

RF-N10-4-96

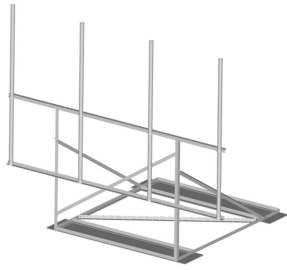

Non-Penetrating Roof Frame, 10 ft face, four 2-3/8 in OD x 96 in pipes

OBSOLETE

This product was discontinued on: December 12, 2022

Replaced By:

RF-NL10-3-96

Non-Penetrating Roof Frame, 10 ft face, three 3-1/2 in OD x 96 in pipes

Product Classification

Product Type Non-penetrating roof frame

General Specifications

Mounting Non-penetrating

Note Four 120 in x 8 in panel antennas per sector

Pipe, quantity 4

Dimensions

Height 2,438.4 mm | 96 in

Face Width 3.2 m | 10.5 ft

Width 3,200.4 mm | 126 in

Length 2.53 m | 8.3 ft

Pipe Length 2,438.4 mm | 96 in

Pipe Outer Diameter 60.96 mm | 2.4 in

RF-N10-4-96

Outline Drawing

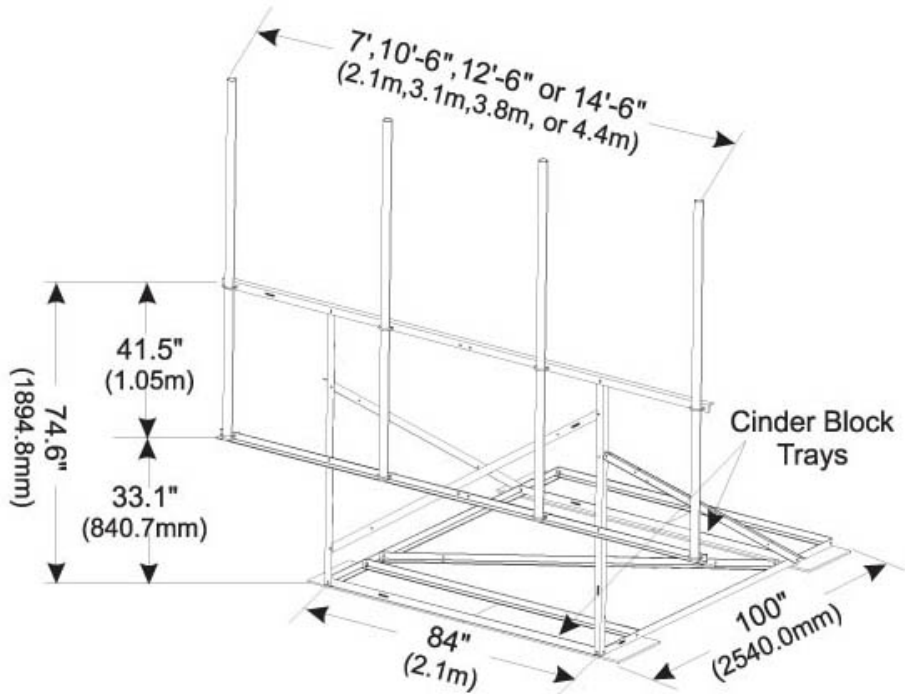

Material Specifications

Material Type Hot dip galvanized steel

Mechanical Specifications

Wind Rating 85 mph (BWS) at 100 ft AGL using Exposure C per UBC

Wind Rating Test Method TIA/EIA-222

Packaging and Weights

Included Rubber mats, with or without pipe mounts

Packaging quantity 1

Weight, net 213.9 kg | 471.568 lb

Regulatory Compliance/Certifications

Agency	Classification
ISO 9001:2015	Designed, manufactured and/or distributed under this quality management system

RF-N10-4-96



Included Products

- MT-651-96 – Plain End Pipe, 2-3/8 in OD x 96 in .120" A500C 46Ksi
- RF-N10-B – Non-Penetrating Roof Frame, 10 ft face, pipe not included

* Footnotes

Wind Rating BWS—Base Wind Speed; FBC—Florida Building Code