

QT-SF14-4-72

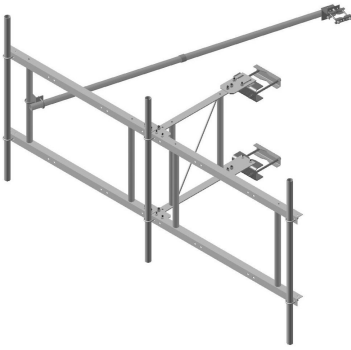

Quik-Tee® Sector Frame, 14 ft face, includes pipe mounts

OBSOLETE

This product was discontinued on: July 31, 2015

Replaced By:

SF-SU14-4-72

Stand-Off Sector Frame, 14 ft face, includes pipe

Product Classification

Product Type Tower T-Frame Kit

General Specifications

Mounting Angle 60°, 203.2 mm (8 in) | Angle 90°, 152.4 mm (6 in) | Straight or tapered legs up to 203.2 mm (8 in) OD

Note Four 72 in x 8 in panel antennas per sector

Pipe, quantity 4

Tower Taper Non-tapered | Tapered

Dimensions

Height 1,828.8 mm | 72 in

Face Width 4.42 m | 14.5 ft

Width 4,419.6 mm | 174 in

Length 1,219.2 mm | 48 in

Pipe Length 1,828.8 mm | 72 in

Mounting Diameter, maximum 203.2 mm | 8 in

Mounting Diameter, minimum 0 mm | 0 in

Pipe Outer Diameter 60.96 mm | 2.4 in

Stand-off Distance 1,219.2 mm | 48 in

QT-SF14-4-72

Outline Drawing



Material Specifications

Material Type Hot dip galvanized steel

Mechanical Specifications

Wind Rating 90 mph (BWS) at 150 ft AGL

Wind Rating Test Method TIA/EIA-222

Wind Rating with Additional Stiff Arm 120 mph (BWS) at 150 ft AGL | 140 mph (3-second gust) at 150 ft AGL using Exposure D per FBC

Environmental Specifications

EPA with 1/2 in (12 mm) radial ice 1.914 m² | 20.6 ft²

QT-SF14-4-72

EPA without ice 1.514 m² | 16.3 ft²

Packaging and Weights

Included Clamps | Frame | Pipe mounts | Saddle mounts | Stiff arm

Packaging quantity 1

Weight, net 231.196 kg | 509.7 lb

Regulatory Compliance/Certifications

Agency

ISO 9001:2015

Classification

Designed, manufactured and/or distributed under this quality management system



Included Products

- MT-651 - Plain End Pipe, 2-3/8 in OD x 72 in .120" A500C 46Ksi
- QT-SF14-B - Quik-Tee® Sector Frame, 14 ft face face

* Footnotes

Wind Rating BWS—Base Wind Speed; FBC—Florida Building Code

Wind Rating with Additional Stiff Arm BWS—Base Wind Speed; FBC—Florida Building Code

EPA with 1/2 in (12 mm) radial ice EPA—Effective Projected Area

EPA without ice EPA—Effective Projected Area