

QT-SF10-3-72

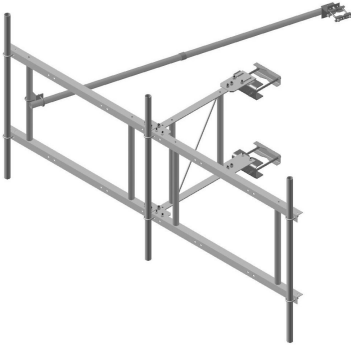

Quik-Tee® Sector Frame, 10 ft face, includes pipe mounts

OBSOLETE

This product was discontinued on: July 31, 2015

Replaced By:

SF-SU10-3-72

Stand-Off Sector Frame, 10 ft face, includes pipe

Product Classification

Product Type Tower T-Frame Kit

General Specifications

Mounting	Angle 60°, 203.2 mm (8 in) Angle 90°, 152.4 mm (6 in) Straight or tapered legs up to 203.2 mm (8 in) OD
Note	Four 72 in x 8 in panel antennas per sector
Pipe, quantity	3
Tower Taper	Non-tapered Tapered

Dimensions

Height	1,828.8 mm 72 in
Face Width	3.2 m 10.5 ft
Width	3,200.4 mm 126 in
Length	1,219.2 mm 48 in
Pipe Length	1,828.8 mm 72 in
Mounting Diameter, maximum	203.2 mm 8 in
Mounting Diameter, minimum	0 mm 0 in
Pipe Outer Diameter	60.96 mm 2.4 in
Stand-off Distance	1,219.2 mm 48 in

QT-SF10-3-72

Outline Drawing



Material Specifications

Material Type Hot dip galvanized steel

Mechanical Specifications

Wind Rating 90 mph (BWS) at 150 ft AGL

Wind Rating Test Method TIA/EIA-222

Wind Rating with Additional Stiff Arm 120 mph (BWS) at 150 ft AGL | 140 mph (3-second gust) at 150 ft AGL using Exposure D per FBC

Environmental Specifications

EPA with 1/2 in (12 mm) radial ice 1.626 m² | 17.5 ft²

QT-SF10-3-72

EPA without ice 1.263 m² | 13.6 ft²

Packaging and Weights

Included Clamps | Frame | Pipe mounts | Saddle mounts | Stiff arm

Packaging quantity 1

Weight, net 180.983 kg | 399 lb

Regulatory Compliance/Certifications

Agency

ISO 9001:2015

Classification

Designed, manufactured and/or distributed under this quality management system



Included Products

- MT-651 - Plain End Pipe, 2-3/8 in OD x 72 in .120" A500C 46Ksi
- QT-SF10-B - Quik-Tee® Sector Frame, 10 ft face

* Footnotes

Wind Rating BWS—Base Wind Speed; FBC—Florida Building Code

Wind Rating with Additional Stiff Arm BWS—Base Wind Speed; FBC—Florida Building Code

EPA with 1/2 in (12 mm) radial ice EPA—Effective Projected Area

EPA without ice EPA—Effective Projected Area