

HTT-B8HG000000N000



NOVUX™ Hardened Tap Terminal, 30/70, 12 dB, One Input port, 8 drop ports and one Through port, Stubless

- NOVUX™ Hardened Tap Terminals incorporate hardened connector technology that is designed to withstand the rugged outside plant environment
- Hardened connectors are factory-integrated and environmentally sealed for use in optical drop cable deployments
- Plug and play adapter ports ensure rapid cable installment in the outside plant access section of the network
- NOVUX™ HTT terminals are available in 2-port, 4-port and 8-port models, depending on the number of drop ports required. Each model is available with a range of tap values depending on how much optical power should be dropped off at each location
- Available with flat dielectric and flat toneable/locatable dielectric cable
- NOVUX™ smaller terminal size for aesthetics and allowing installation in constrained spaces
- NOVUX™ terminals are available in Black (RAL# 9005) or Gray (RAL# 7035)
- CommScope Product ID plate with QR code link to product documents and C-Track

Product Classification

Regional Availability	Asia EMEA Latin America North America
Product Type	Access terminal, with splitter/tap
Product Brand	NOVUX™
Product Series	HTT
Minimum Order Quantity	1

General Specifications

Distribution Type	8-port tap
Drop Port Type	Hardened full-size SC/APC
Enclosure Color	Black (RAL 9005)
Input Tap, quantity	1
Mounting	Handhole Pedestal Pole Strand
Port Type	Hardened full-size SC/APC
Split Ratio	70/30
Stub Type	No tail
Tap Ports, quantity	8
Thru Tap, quantity	1

HTT-B8HG000000N000

Dimensions

Height	80 mm 3.15 in
Width	95 mm 3.74 in
Length	192 mm 7.559 in
Cable Length, stub	0 ft (0 m)

Dimension Drawing

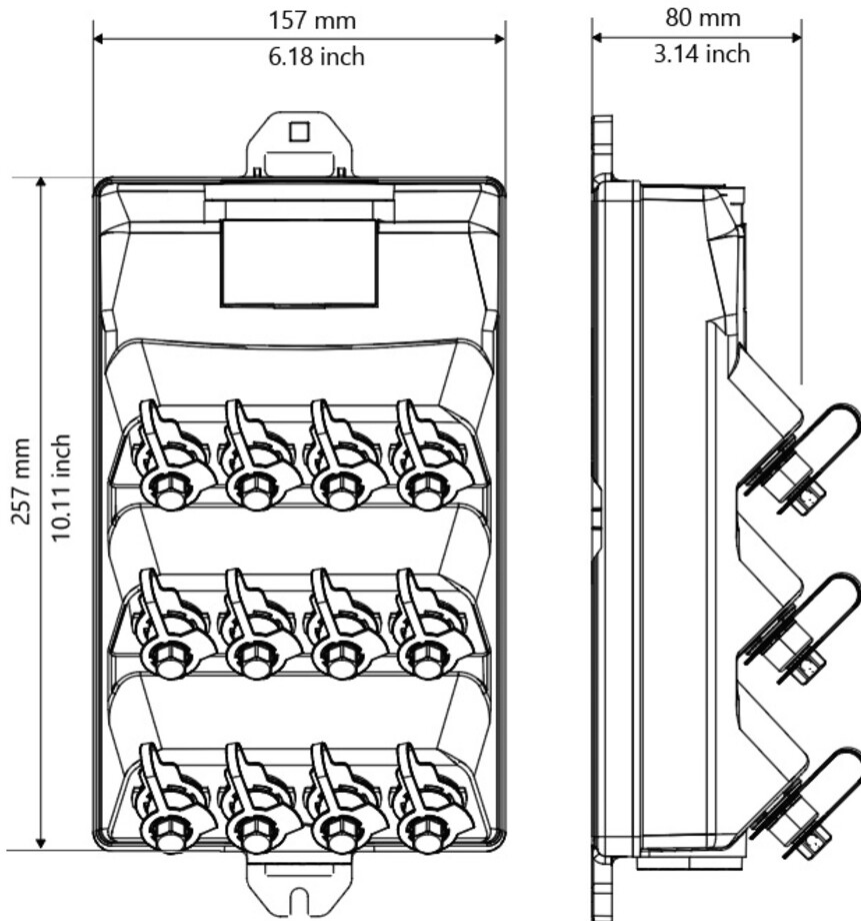

Port Configuration

NOVUX HT	TECHNOLOGIES AVAILABLE	SMALL	MEDIUM	LARGE
HTT Series	Optical taps	2 drops	4 drops	8 drops

Ordering Tree

HTT-B8HG000000N000

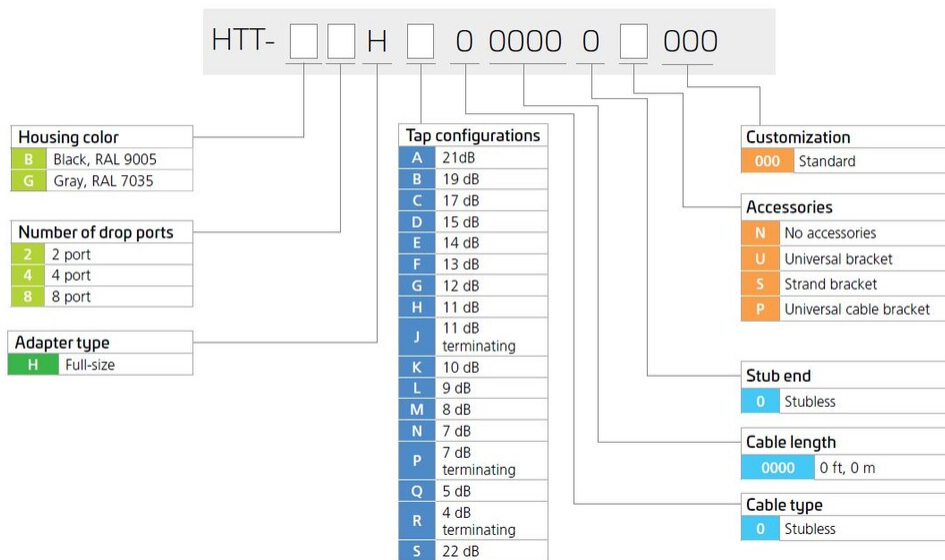

Material Specifications

Enclosure Material Type Hardened plastic

Optical Specifications

Operating Wavelength Range 1260 – 1635 nm

Tap Drop Loss, maximum 13.3 dB

Tap Thru Loss, maximum 6.8 dB

Tap Value 12 dB

Environmental Specifications

Operating Temperature -40 °C to +65 °C (-40 °F to +149 °F)

Relative Humidity 5%–100%, condensing

Environmental Space Above ground | Below ground

Qualification Standards IEC 60529, IP68 + 2 m waterhead | IEC 61753-1, category G

UV Resistance UV stabilized

Packaging and Weights

Packaging quantity 1

Packaging Type Box | Carton

Regulatory Compliance/Certifications

HTT-B8HG000000N000

Agency**Classification**

CHINA-ROHS

Below maximum concentration value

ISO 9001:2015

Designed, manufactured and/or distributed under this quality management system

REACH-SVHC

Compliant as per SVHC revision on www.commscope.com/ProductCompliance

ROHS

Compliant

UK-ROHS

Compliant

