

PM-XT-36



Stand-Off Pipe Mount, 36 in stand-off

Product Classification

Product Type Pipe mount

General Specifications

Mounting Saddle mounts

Pipe, quantity 1

Tower Taper Non-tapered

Dimensions

Height 1,600.2 mm | 63 in

Width 152.4 mm | 6 in

Length 914.4 mm | 36 in

Pipe Length 1,600.2 mm | 63 in

Pipe Outer Diameter 114.3 mm | 4.5 in

Stand-off Distance 914.4 mm | 36 in

PM-XT-36

Outline Drawing

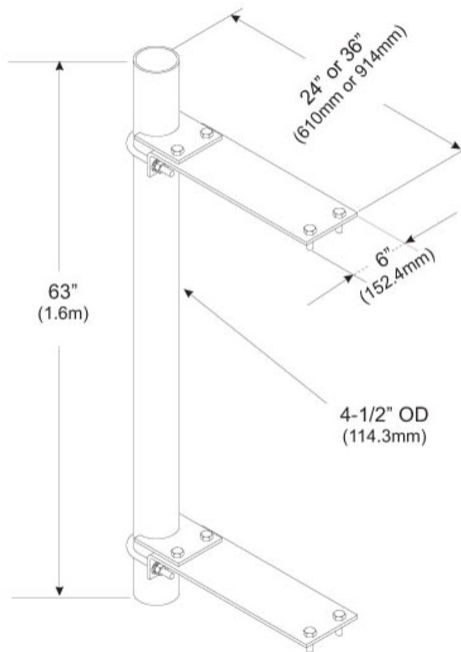

Material Specifications

Material Type Hot dip galvanized steel

Packaging and Weights

Included Pipe mounts

Packaging quantity 1

Weight, net 58.3 kg | 128.529 lb

Regulatory Compliance/Certifications

Agency **Classification**

PM-XT-36

CHINA-ROHS	Above maximum concentration value
ISO 9001:2015	Designed, manufactured and/or distributed under this quality management system
ROHS	Compliant/Exempted
UK-ROHS	Compliant/Exempted

