

REV	MCO	DWN	DATE
A	20019792	TH	12/28/98
B	20236325	RCR	25-MAR-08

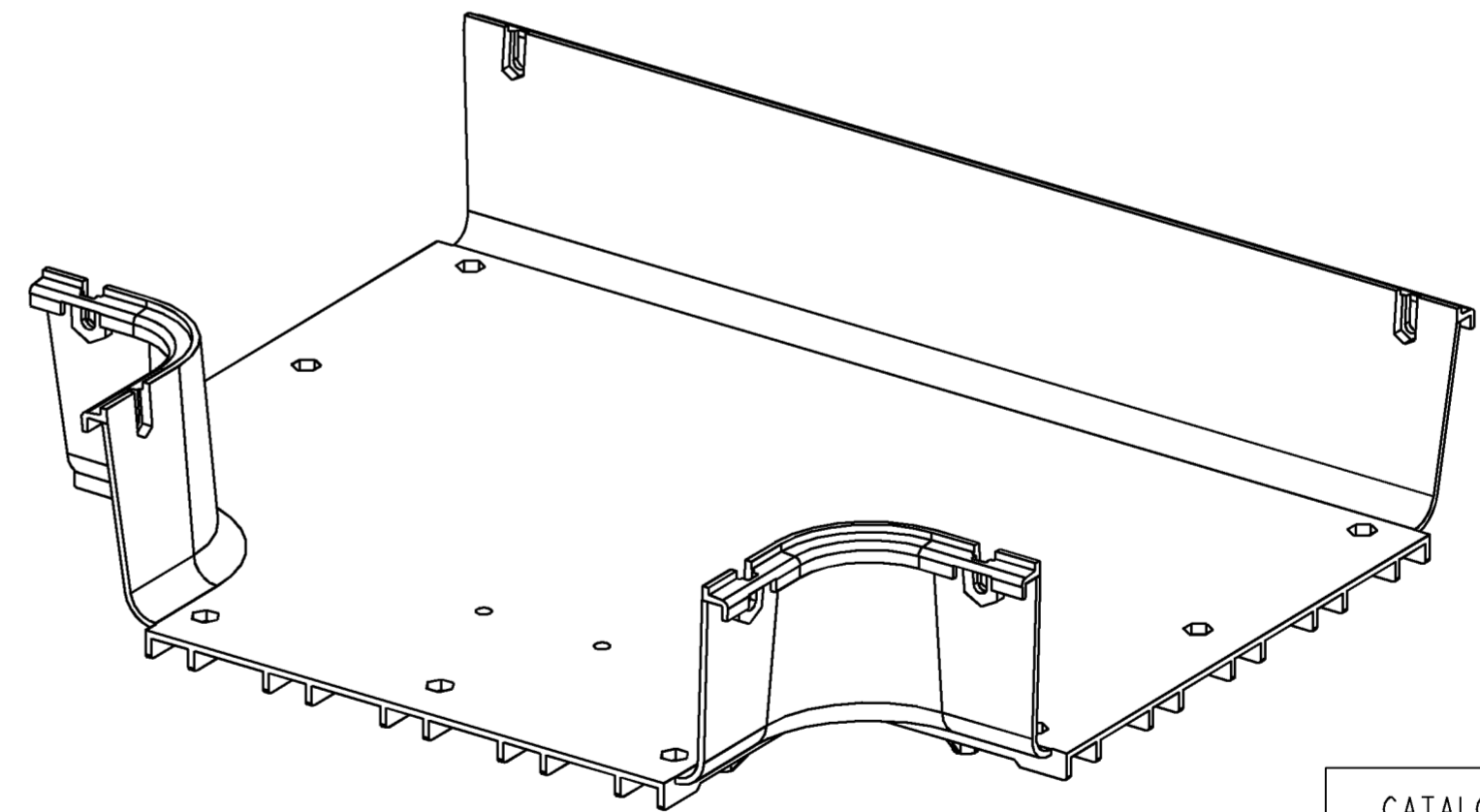
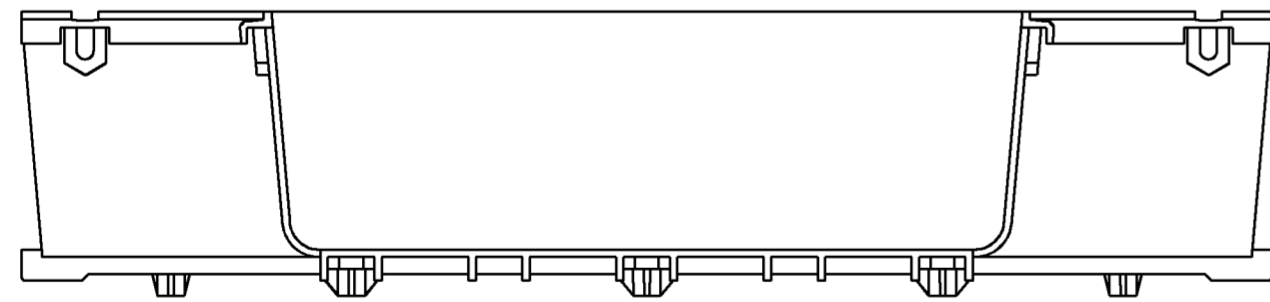
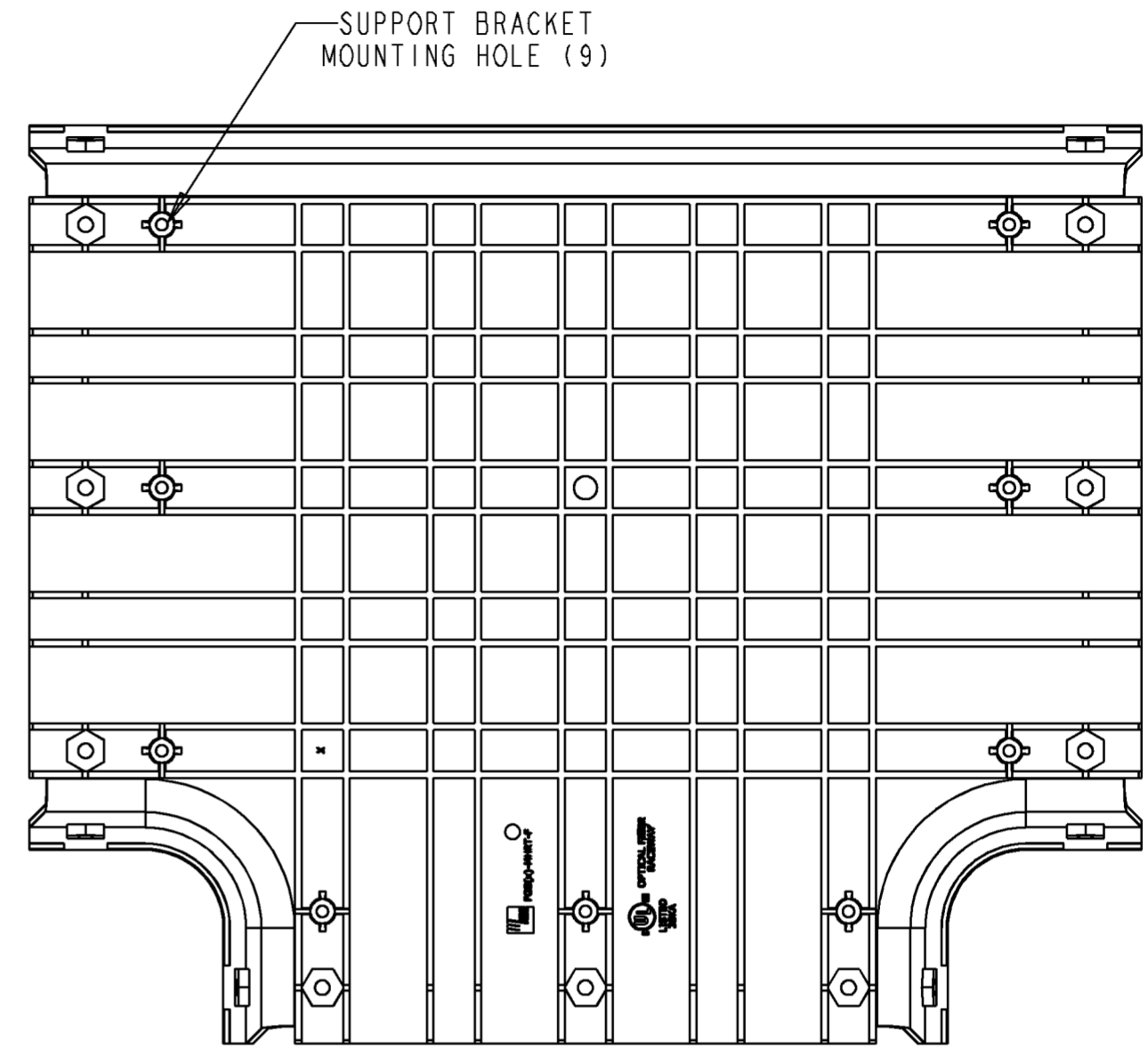
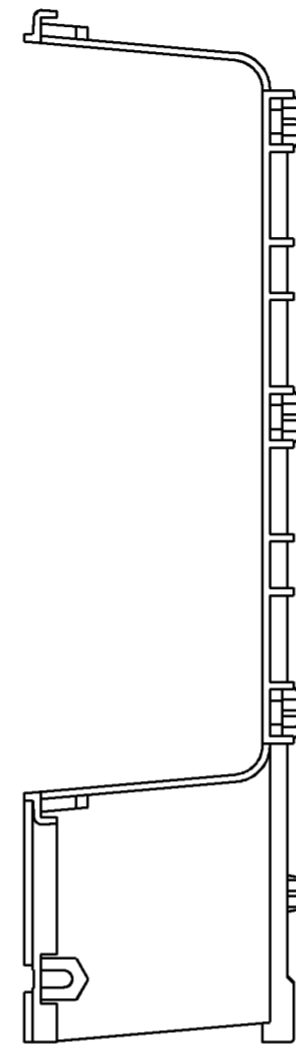
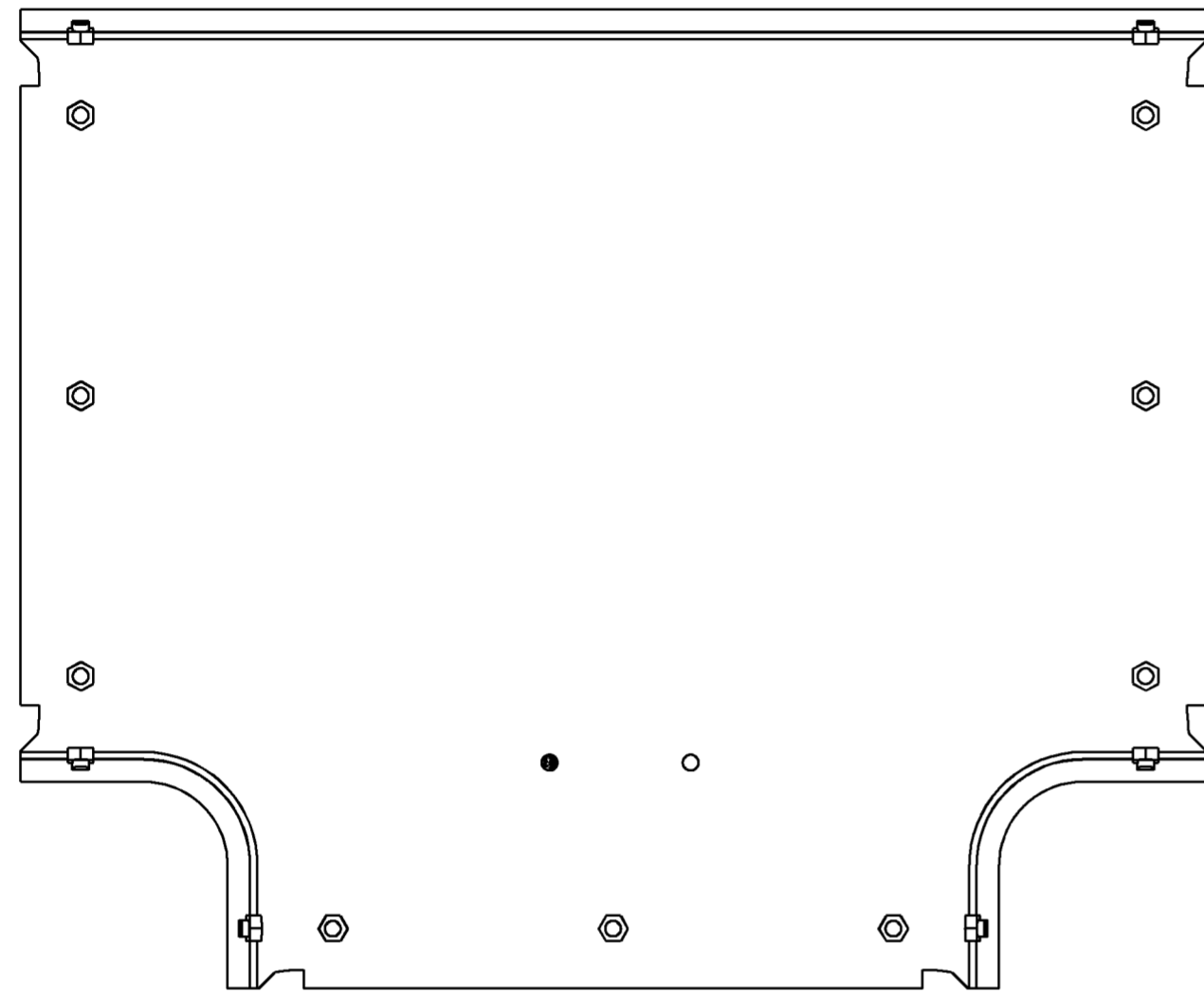

SCALE 0.310

CATALOG NO.	COLOR
FGS-MHRT-F	YELLOW
FGSO-MHRT-F	ORANGE
FGSB-MHRT-F	BLACK

NOTES:

1. MATERIAL IS SELF EXTINGUISHING WITH A UL 94 RATING OF V-0.



INFORMATION ON THIS DOCUMENT IS PROPRIETARY TO ADC AND SHALL NOT BE USED, COPIED, REPRODUCED OR DISCLOSED IN WHOLE OR IN PART WITHOUT WRITTEN CONSENT OF ADC.

ALL DIMS AND TOLERANCES .XX:±.01 ARE INCHES UNLESS .XXX:±.005 OTHERWISE SPECIFIED ANGULAR:±1°

DO NOT SCALE DRAWING

TITLE TEE, HORIZ, 4X12 INSTALLATION DWG

DRAWING NUMBER 1044464

ENGR: T. HAATAJA
DWN: T. HAATAJA

SHT. 1 OF 1

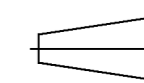
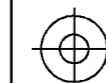

DIMENSIONS IN INCHES
THIRD ANGLE PROJECTION