

MC-K12L-9-96



Monopole Co-location T-Frame Kit, 30 in to 60 in OD, 12 ft face, includes pipe

OBSOLETE

This product was discontinued on: August 18, 2022

Replaced By:

MC-K12M-9-96

Monopole Co-location T-Frame kit, 12 in to 50 in OD, 12 ft 6 in face, includes pipe

Product Classification

Product Type Monopole T-frame kit

General Specifications

Mounting Monopole, 762–1524 mm (30–60 in) OD

Pipe, quantity 9

Sectors, quantity 3

Dimensions

Height 2,438.4 mm | 96 in

Face Width 3.81 m | 12.5 ft

Width 3810 mm | 150 in

Length 914.4 mm | 36 in

Pipe Length 2,438.4 mm | 96 in

Mounting Diameter, maximum 1524 mm | 60 in

Mounting Diameter, minimum 762 mm | 30 in

Pipe Outer Diameter 60.96 mm | 2.4 in

Stand-off Distance 914.4 mm | 36 in

MC-K12L-9-96

Outline Drawing



Material Specifications

Material Type Hot dip galvanized steel

Mechanical Specifications

Wind Rating 120 mph (BWS) at 150 ft AGL | 140 mph (3-second gust) at 150 ft AGL using Exposure D per FBC

Wind Rating Criteria Four 72 in x 8 in panel antennas per sector

Wind Rating Test Method TIA/EIA-222

Environmental Specifications

EPA with 1/2 in (12 mm) radial ice 1.347 m² | 14.5 ft²

EPA without ice 1.059 m² | 11.4 ft²

MC-K12L-9-96

Packaging and Weights

Included	Cellular pipe frames Pipe mounts Ring mount Stand-off arms
Packaging quantity	1
Weight, net	565.584 kg 1,246.9 lb

Regulatory Compliance/Certifications

Agency	Classification
ISO 9001:2015	Designed, manufactured and/or distributed under this quality management system



Included Products

MC-K12L-B	- Monopole Co-location T-Frame Kit, 30 in to 60 in OD, 12 ft face
MT-219-H	- Pipe Mount Kit - 2-3/8" TO 3-1/2" PIPE - pipe not included
MT-651-96	- Plain End Pipe, 2-3/8 in OD x 96 in .120" A500C 46Ksi

* Footnotes

Wind Rating	BWS—Base Wind Speed; FBC—Florida Building Code
EPA with 1/2 in (12 mm) radial ice	EPA—Effective Projected Area
EPA without ice	EPA—Effective Projected Area

MC-K12L-B



Monopole Co-location T-Frame Kit, 30 in to 60 in OD, 12 ft face

Product Classification

Product Type Monopole T-frame kit

General Specifications

Mounting Monopole, 762–1524 mm (30–60 in) OD

Pipe, quantity 0

Sectors, quantity 3

Dimensions

Height 254 mm | 10 in

Face Width 3.81 m | 12.5 ft

Width 3810 mm | 150 in

Length 914.4 mm | 36 in

Mounting Diameter, maximum 1524 mm | 60 in

Mounting Diameter, minimum 762 mm | 30 in

Pipe Outer Diameter 60.96 mm | 2.4 in

Stand-off Distance 914.4 mm | 36 in

MC-K12L-B

Outline Drawing

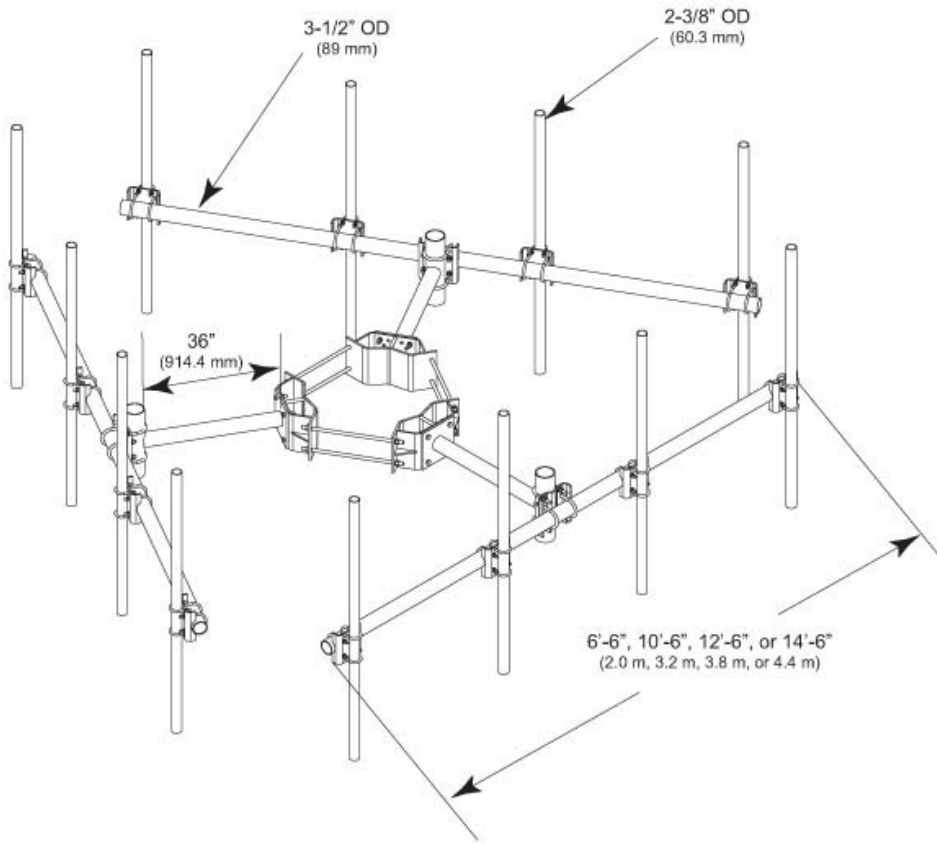

Material Specifications

Material Type Hot dip galvanized steel

Mechanical Specifications

Wind Rating 120 mph (BWS) at 150 ft AGL | 140 mph (3-second gust) at 150 ft AGL using Exposure D per FBC

Wind Rating Criteria Four 72 in x 8 in panel antennas per sector

Wind Rating Test Method TIA/EIA-222

Environmental Specifications

EPA with 1/2 in (12 mm) radial ice 1.347 m² | 14.5 ft²

EPA without ice 1.059 m² | 11.4 ft²

MC-K12L-B

Packaging and Weights

Included	Cellular pipe frames Ring mount Stand-off arms
Packaging quantity	1
Weight, net	399.207 kg 880.1 lb

Regulatory Compliance/Certifications

Agency	Classification
ISO 9001:2015	Designed, manufactured and/or distributed under this quality management system



* Footnotes

Wind Rating	BWS—Base Wind Speed; FBC—Florida Building Code
EPA with 1/2 in (12 mm) radial ice	EPA—Effective Projected Area
EPA without ice	EPA—Effective Projected Area

MT-219-H

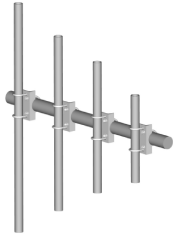

Pipe Mount Kit - 2-3/8" TO 3-1/2" PIPE - pipe not included

Product Classification

Product Type Pipe mount kit

General Specifications

Mounting Pipe, 60.3 mm (2-3/8 in) OD | Pipe, 88.9 mm (3-1/2 in) OD

Dimensions

Height 254 mm | 10 in

Width 127 mm | 5 in

Length 127 mm | 5 in

Mounting Diameter, maximum 88.9 mm | 3.5 in

Mounting Diameter, minimum 60.325 mm | 2.375 in

Material Specifications

Material Type Hot dip galvanized steel

Packaging and Weights

Included Crossover bracket | U-bolts

Packaging quantity 1

Weight, net 4.9 kg | 10.803 lb

Regulatory Compliance/Certifications

Agency	Classification
ISO 9001:2015	Designed, manufactured and/or distributed under this quality management system
REACH-SVHC	Compliant as per SVHC revision on www.commscope.com/ProductCompliance
ROHS	Compliant
UK-ROHS	Compliant



MT-651-96



Plain End Pipe, 2-3/8 in OD x 96 in .120" A500C 46Ksi

Product Classification

Product Type Plain end pipe

General Specifications

Pipe, quantity 1

Dimensions

Height 60.96 mm | 2.4 in
Width 60.96 mm | 2.4 in
Length 2,438.4 mm | 96 in
Pipe Length 2,438.4 mm | 96 in
Pipe Outer Diameter 60.96 mm | 2.4 in
Material Thickness 3.048 mm | 0.12 in

Material Specifications

Material Type A500 | Hot dip galvanized steel
Material Grade C
Material Strength 46 KSI

Packaging and Weights

Included Pipe
Packaging quantity 1
Weight, net 10 kg | 22.046 lb

Regulatory Compliance/Certifications

Agency	Classification
CHINA-ROHS	Above maximum concentration value
ISO 9001:2015	Designed, manufactured and/or distributed under this quality management system

MT-651-96

ROHS Compliant/Exempted

UK-ROHS Compliant/Exempted

