

# HXT-B2MFA1500FN000



NOVUX™ Hardened Indexing Terminal, 12F, 2 Fiber Branching, Dielectric flat loose tube, 1500 ft/457 m HMFOC plug (female/no pin) tail

- NOVUX™ Hardened Multi-fiber Terminals incorporate hardened connector technology that is designed to withstand the rugged outside plant environment
- Hardened connectors are factory-integrated and environmentally sealed for use in optical drop cable deployments
- Plug and play adapter ports ensure rapid cable installment in the outside plant access section of the network
- NOVUX™ HXT fiber indexing terminals are available with 1:4 or 1:8 splitter and optional multi-use ports, Index Only and Index Branching 2 to 6 fiber solutions
- Available with flat dielectric and flat toneable/locatable dielectric cable
- NOVUX™ smaller terminal size for aesthetics and allowing installation in constrained spaces
- NOVUX™ terminals are available in Black (RAL# 9005) or Gray (RAL# 7035)
- CommScope Product ID plate with QR code link to product documents and C-Track

## Product Classification

|                               |   |
|-------------------------------|---|
| <b>Regional Availability</b>  | Asia   EMEA   Latin America   North America |
| <b>Product Type</b>           | Access terminal, without splitter/tap       |
| <b>Product Brand</b>          | NOVUX™                                      |
| <b>Product Series</b>         | HXT   |
| <b>Minimum Order Quantity</b> | 1   |

## General Specifications

|                               |  |
|-------------------------------|--|
| <b>Cable Type</b>             | Dielectric - Flat - Loose Tube                   |
| <b>Cable, quantity</b>        | 1  |
| <b>Distribution Type</b>      | 1 port   |
| <b>Drop Port Type</b>         | Hardened multi-fiber (HMFOC) jack, male/pinned   |
| <b>Drop Port, quantity</b>    | 1  |
| <b>Enclosure Color</b>        | Black (RAL 9005)                                 |
| <b>Forward Port Type</b>      | Hardened multi-fiber (HMFOC) jack, male/pinned   |
| <b>Forward Port, quantity</b> | 1  |
| <b>Mounting</b>               | Handhole   Pedestal   Pole   Strand              |
| <b>Port Type</b>              | Hardened multi-fiber (HMFOC) jack, male/pinned   |
| <b>Port, quantity</b>         | 2  |
| <b>Stub Type</b>              | Hardened multi-fiber (HMFOC) plug, female/no pin |

# HXT-B2MFA1500FN000

## Dimensions

|                             |                               |
|-----------------------------|-------------------------------|
| <b>Height</b>               | 80 mm   3.15 in               |
| <b>Width</b>                | 95 mm   3.74 in               |
| <b>Length</b>               | 192 mm   7.58 in              |
| <b>Cable Length, stub</b>   | 1500 ft (457 m)               |
| <b>Cable Outer Diameter</b> | 4.3 x 8.0 mm (0.17 x 0.31 in) |

## Dimension Drawing

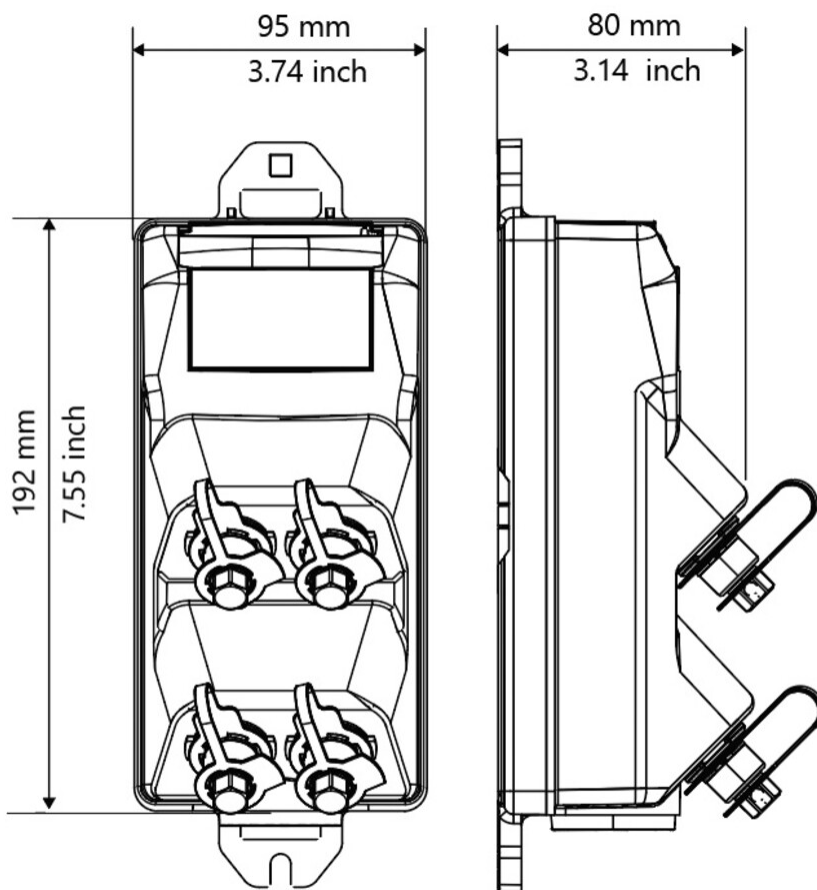

## Port Configuration

# HXT-B2MFA1500FN000

| NOVUX HT   | TECHNOLOGIES AVAILABLE | SMALL                                | MEDIUM                 | LARGE                       |
|------------|------------------------|--------------------------------------|------------------------|-----------------------------|
| HXT Series | Fiber indexing         | 12 fiber index only, 1f              | 12 fiber 1:4           | 12 fiber 1:8                |
|            |                        | 12 fiber index only, 2f              | 12f multi-use 2f + 1:4 | 12 fiber multi-use, 3f +1:4 |
|            |                        | 12 fiber index only, 3f              | 24f multi-use 2f       | 12 fiber multi-use, 4f +1:4 |
|            |                        | 12 fiber index only, 4f              | 24f multi-use 3f       | 12 fiber multi-use, 2f +1:8 |
|            |                        | 12 fiber multi-use, 2f               | 24f multi-use 4f       |                             |
|            |                        | 12 fiber branching, 2 to 6f per port |                        |                             |

## Ordering Tree



## Material Specifications

**Enclosure Material Type** Hardened plastic

## Optical Specifications

**Fiber Type** G.657.A1/A2

**Operating Wavelength Range** 1260 – 1635 nm

**Attenuation Single Ports, maximum** 0.65 dB

**Attenuation Cable Coefficient, maximum** 0.30 dB/km @ 1550 nm | 0.40 dB/km @ 1310 nm

**Insertion Loss, Stub Connector, maximum** 0.65 dB

**Return Loss, Connector, typical** 65 dB

# HXT-B2MFA1500FN000

---

## Environmental Specifications

|                                |   |
|--------------------------------|---|
| <b>Operating Temperature</b>   | -40 °C to +65 °C (-40 °F to +149 °F)                      |
| <b>Relative Humidity</b>       | 5%–100%, condensing                                       |
| <b>Environmental Space</b>     | Above ground   Below ground                               |
| <b>Qualification Standards</b> | IEC 60529, IP68 + 2 m waterhead   IEC 61753-1, category G |
| <b>UV Resistance</b>           | UV stabilized   |

## Packaging and Weights

|                           |   |
|---------------------------|---|
| <b>Packaging quantity</b> | 1   |
| <b>Packaging Type</b>     | Box   Universal spool, cardboard: terminal is on top of the spool, stub deploys first |

## Regulatory Compliance/Certifications

| <b>Agency</b> | <b>Classification</b>  |
|---------------|--|
| CHINA-ROHS    | Below maximum concentration value  |
| ISO 9001:2015 | Designed, manufactured and/or distributed under this quality management system   |
| REACH-SVHC    | Compliant as per SVHC revision on <a href="http://www.commscope.com/ProductCompliance">www.commscope.com/ProductCompliance</a> |
| ROHS          | Compliant  |
| UK-ROHS       | Compliant  |

