



TDUX - Inflatable Duct Seal, size 60

- Flexible and reliable wraparound inflatable sealing system for cables
- Fast and easy to install or remove, even when water is flowing out of the duct
- Independent of duct or cable ovality
- Water and airtight up to 50 kPa (7 psi)
- Environmentally friendly, non-toxic and resistant to chemicals

Product Classification

Regional Availability	Latin America North America
Product Type	Cable duct seal
Product Series	TDUX
Ordering Note	When sealing more than two cables in a duct, separate orderable TDUX-CL clips are to be used

Dimensions

Width	120 mm 4.724 in
Length	262 mm 10.315 in
Cable Diameter, maximum	45 mm 1.772 in
Cable Diameter, minimum	18 mm 0.709 in
Conduit Inner Diameter, maximum	60 mm 2.362 in
Conduit Inner Diameter, minimum	45 mm 1.772 in

Dimension Drawing

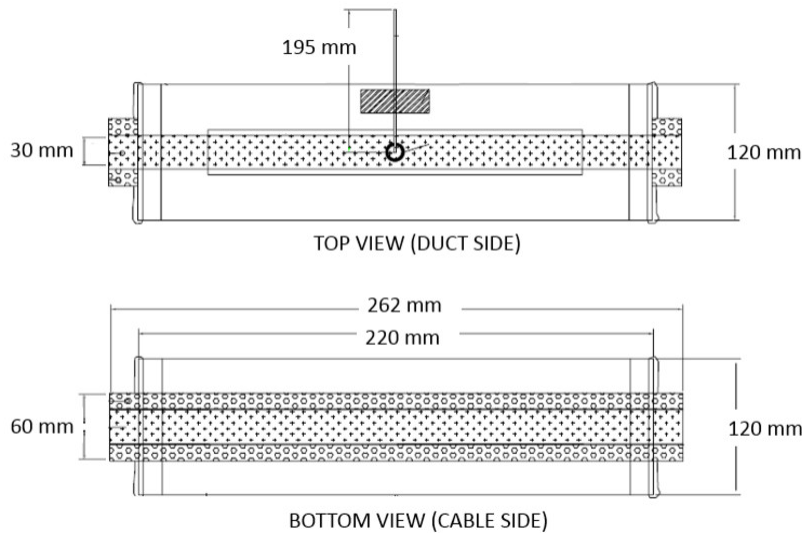

Environmental Specifications

Installation temperature -5 °C to +40 °C (+23 °F to +104 °F)

Packaging and Weights

Included Inflatable bladder with sealing mechanism

Packaging quantity 10

Regulatory Compliance/Certifications

Agency	Classification
CHINA-ROHS	Below maximum concentration value
REACH-SVHC	Compliant as per SVHC revision on www.commscope.com/ProductCompliance
ROHS	Compliant
UK-ROHS	Compliant

