

TC-965-IP  
Rev A, Feb 2017  
www.commscope.com

## Building distributor

### Introduction

Suitable for FTTH applications where easily pre-connectorized splitters modules can be build in. The box is designed In such a way that it is suitable for both spliced and connectorized solutions of the riser cable.

### Kit content



- Box
- Base tray
- Base tower
- Termination units
- Inserts for SMOUV and ANT

### Accessories

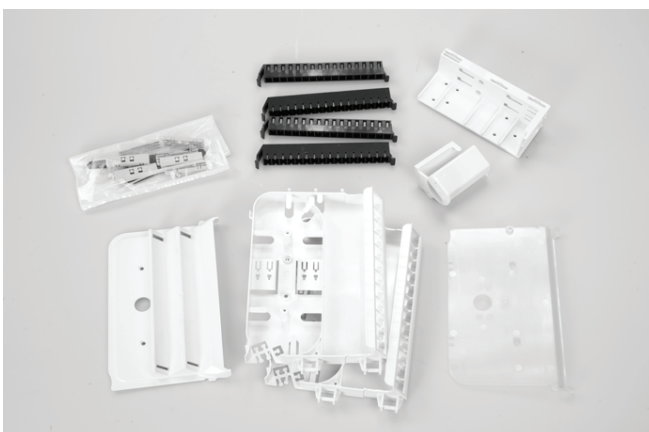

- Tray kit

### Seals

#### Wrap around cable seals

##### Sealblock 6 x 10 mm

Cable diameter (mm)	Foam ( $\pm 5$ mm)
3	95
4	90
5	80
6	75
7	70
8	60
9	50
10	40

##### Sealblock 6 x 15 mm

Cable diameter (mm)	Foam ( $\pm 5$ mm)
9	125
10	115
11	105
12	95
13	85
14	70
15	60

##### Sealblock 3 x 20 mm

Cable diameter (mm)	Foam ( $\pm 5$ mm)
14	155
15	140
16	125
17	110
18	95v
19	85
20	75

##### Sealblock 24 x 8 mm

Cable range	A	B
1.8 – 5 mm		
5 – 7 mm		

##### Sealblock rubber 1 x 18

To use in ports S6-S7 only  
Cable range 3 – 8 mm

##### Standard seals

PG 16  
PG 21  
PG 29  
PG 29 (PTS 24)

## 1 Preparation of the box

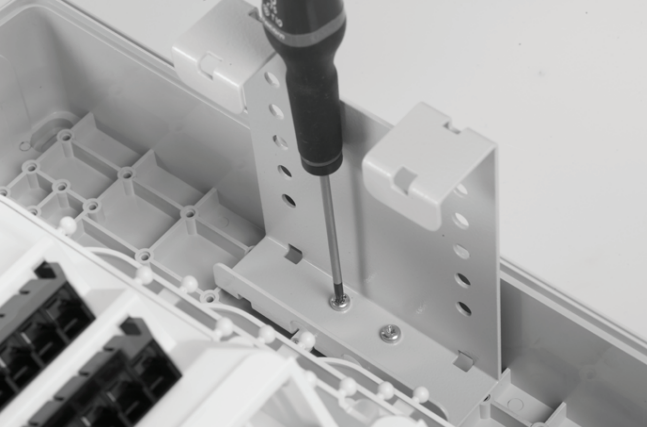

1.1 Install the bracket if loop storage is needed.

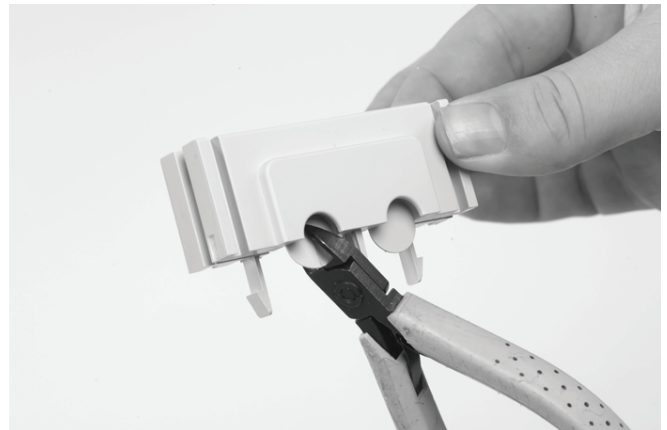
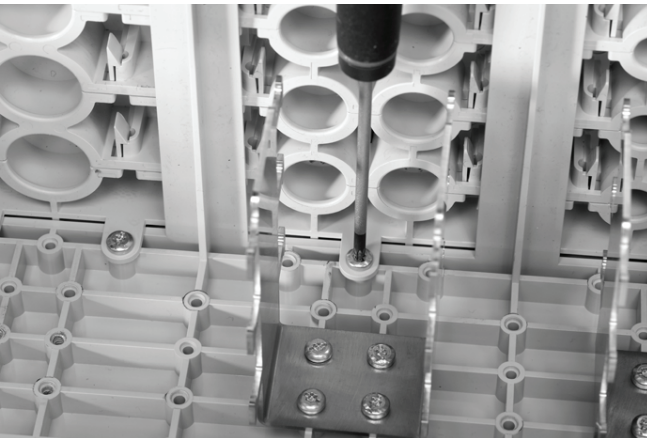
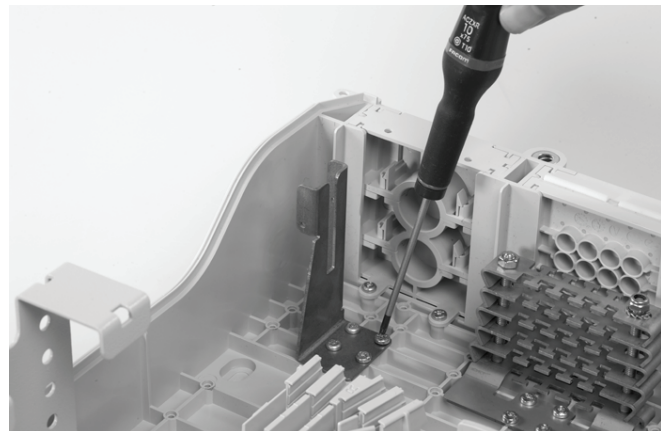

1.3 Install the cable bracket depending the cable seal..  
Cut out plastic part, in case of installing a cable

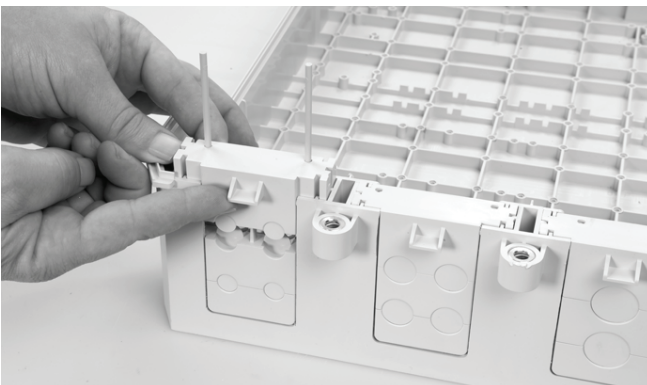
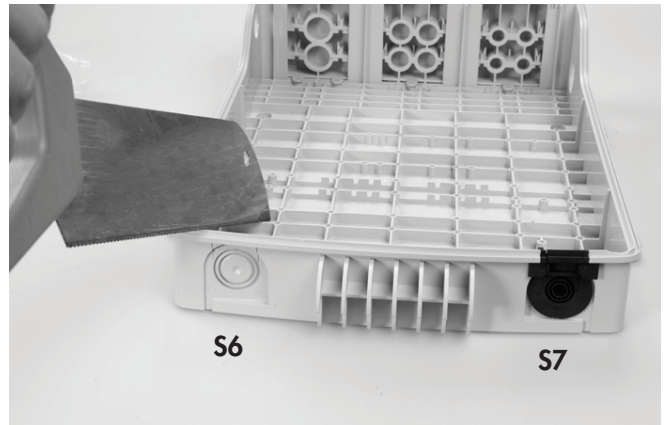

1.4 Use a hacksaw to reach the onion rings, which can be opened with a plier to open the in-line ports (S6/S7).

1.2 Different wrap-around ports are available (including brackets).  
Use two guiding pins to open the ports. Secure the bottom part to the box with the screws.

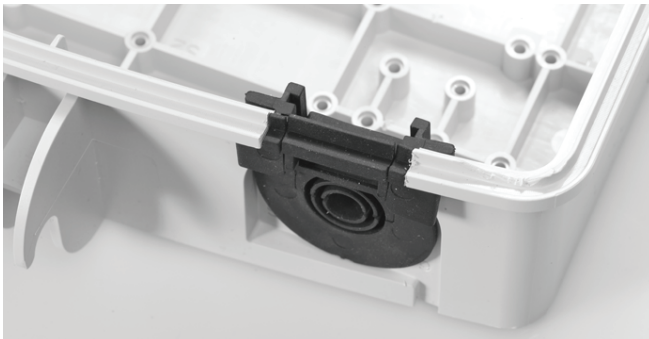

1.5 Install the wrap-around rubber seal into the port.

## 2 Looped cable

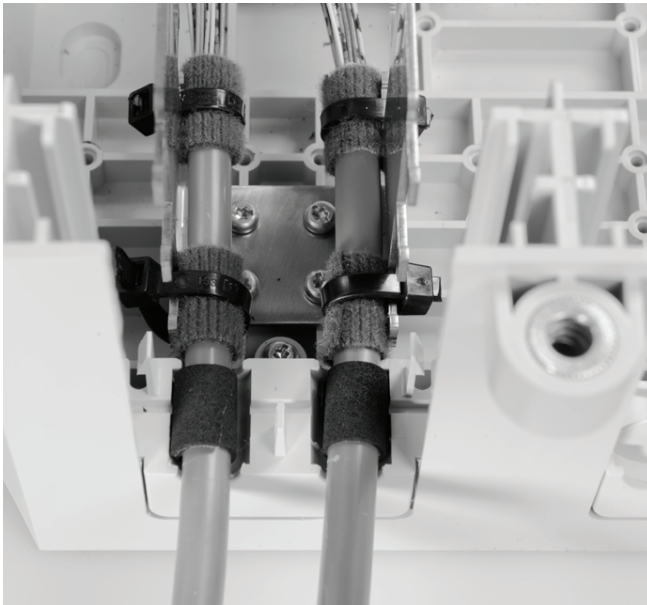

2.1 Cable installation into the wrap around ports. Bracket can be different depending on the port. Secure with hook and loop fastener tape and seal with foam (see length page 1).

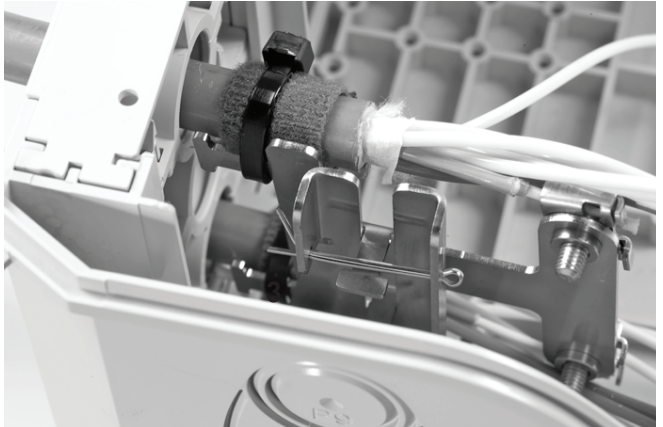
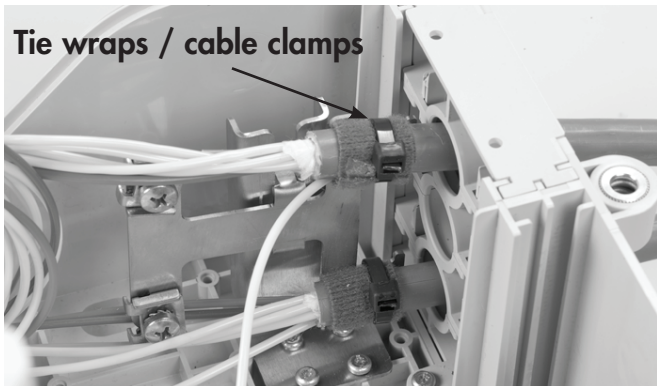

2.2 Install the bracket and terminate the looped cable. Take out the loose tube(s) from the basket for further use.

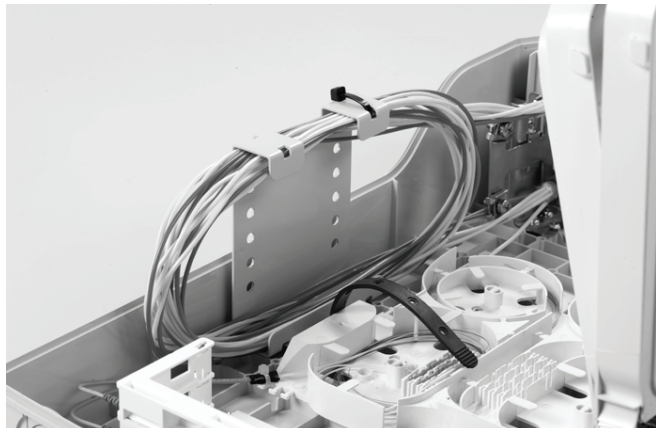

2.3 Store the looped tubes in the basket.

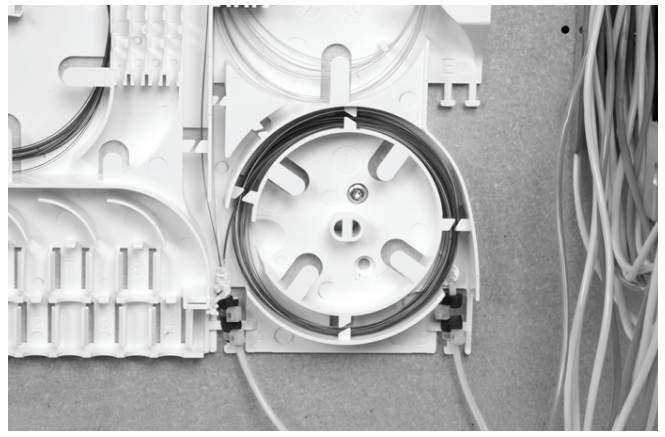
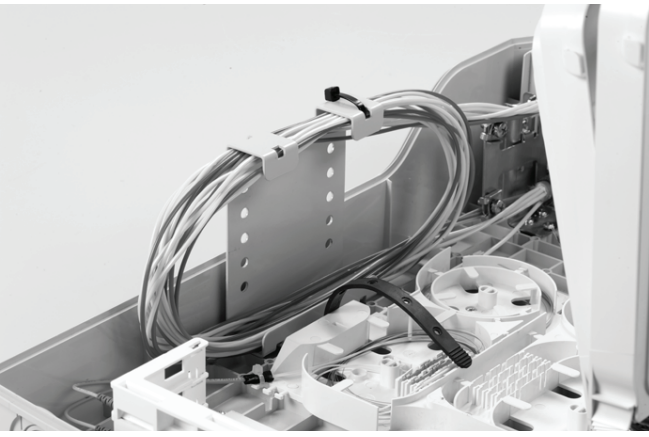

2.6 Store the unused looped fibers in the storage area.

2.4 Route the loose tubes to the base tray. Mark left and right side of the loose tube at their position on the base tray.

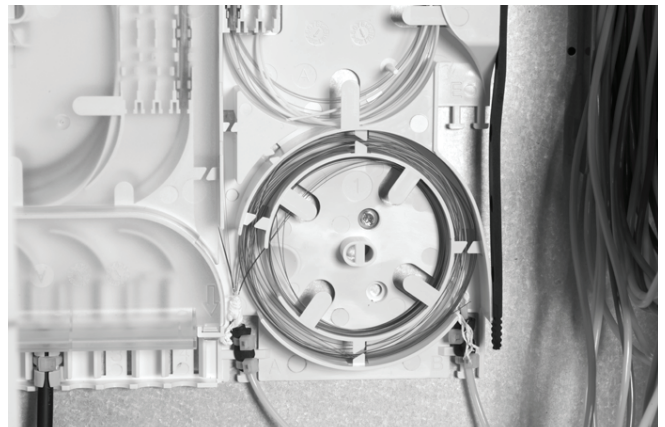

2.7 Store the fibers which will be used later.

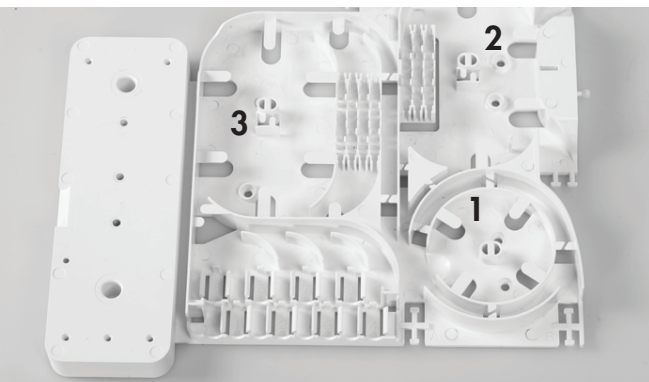

2.5 1: Storage area (looped storage shaved LT)  
 2: Splicing to splitter modules  
 3: Point-to-point applications

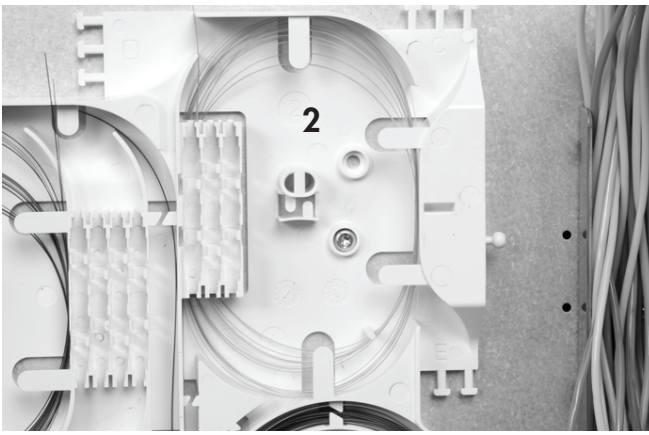

2.8 Store the fibers which will be spliced day 1 to the splitter modules.

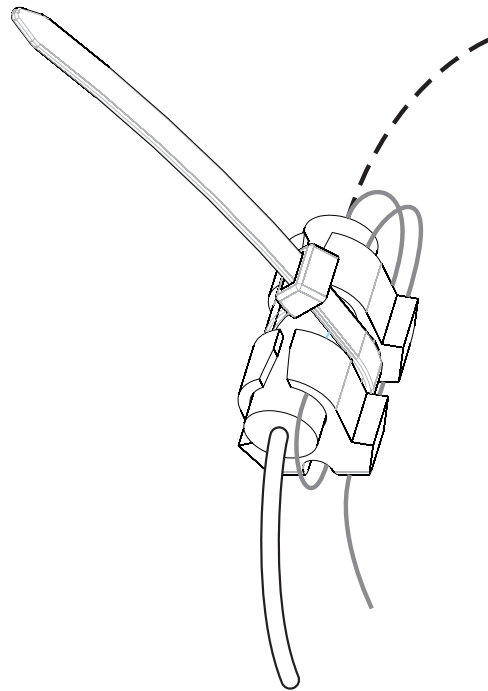

3.3 Wrap one layer of foam (20 mm) on the securing position if needed. Terminate the aramid strength member by securing the cable/pigtail onto the bracket with tie-wrap. Depending the amount of aramid strength member, it needs to be wrapped twice around the bracket.

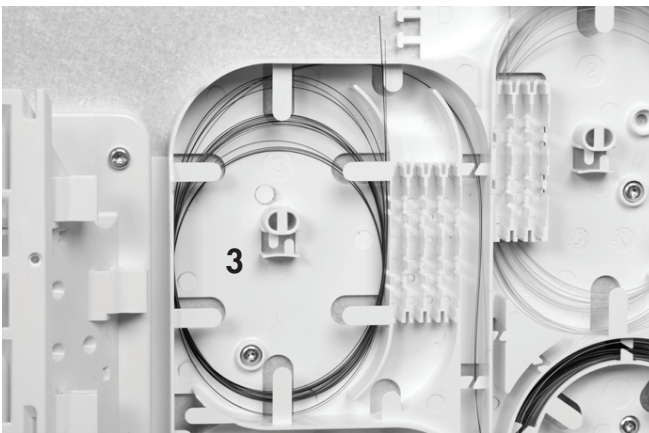

2.9 Store the fibers which will be spliced day 1 for the point-to-point applications.

### 3 Drop cables (point-to-point applications)

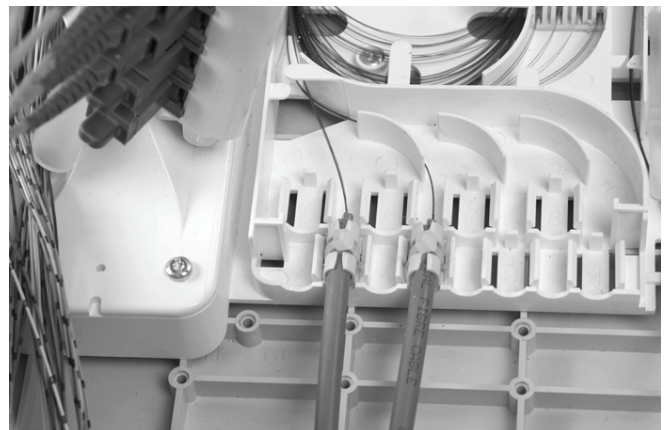

3.4 Install the terminated drop cable in the numbered ports on the base tray.



3.1 Install the drop cable seal and push through the drop cable.

3.2 Remove the outer jacket over a distance of 1.2 m.

## 4 Splitters

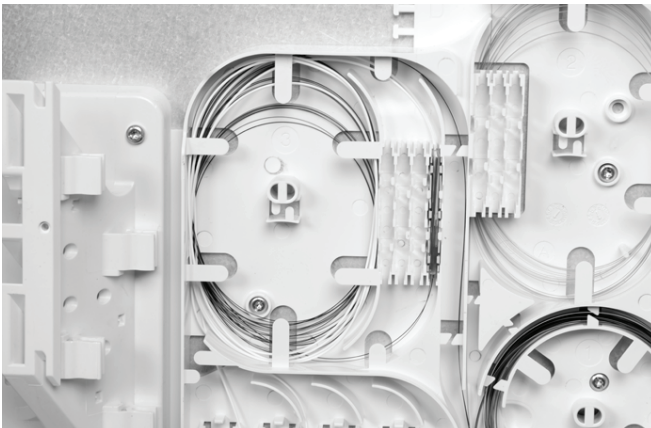

3.5 Splice the fibers from the drop cable to the fibers from the looped cable. In case of SMOUV, use the insert.

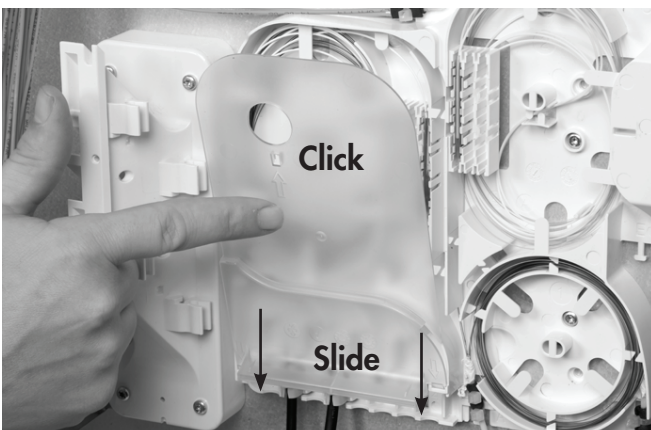

3.6 Install the cover onto the tray.



4.1 Install the splitter holder

#### OCM6 butt



4.2 Install the splitter into the holder and route the pigtails via the bend control.

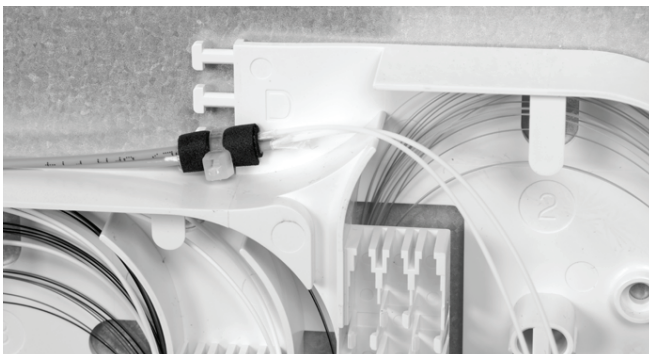
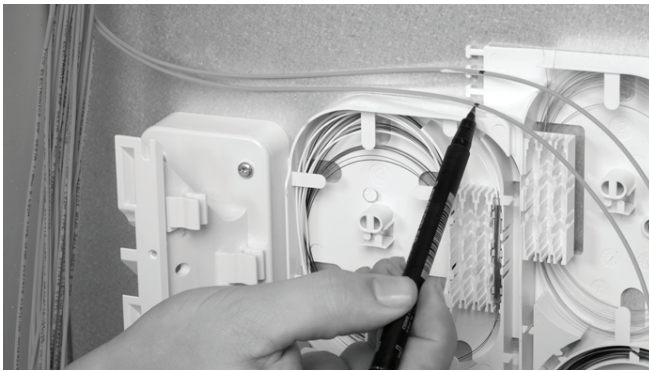

4.3 Route the incoming pigtails of the splitter (marked with red flag) to the base tray (area nr. 2). Remove the outer jacket from the mark over a distance of 1.2m. Secure with foam and tie-wrap onto the base tray.

#### OCM6 in-line

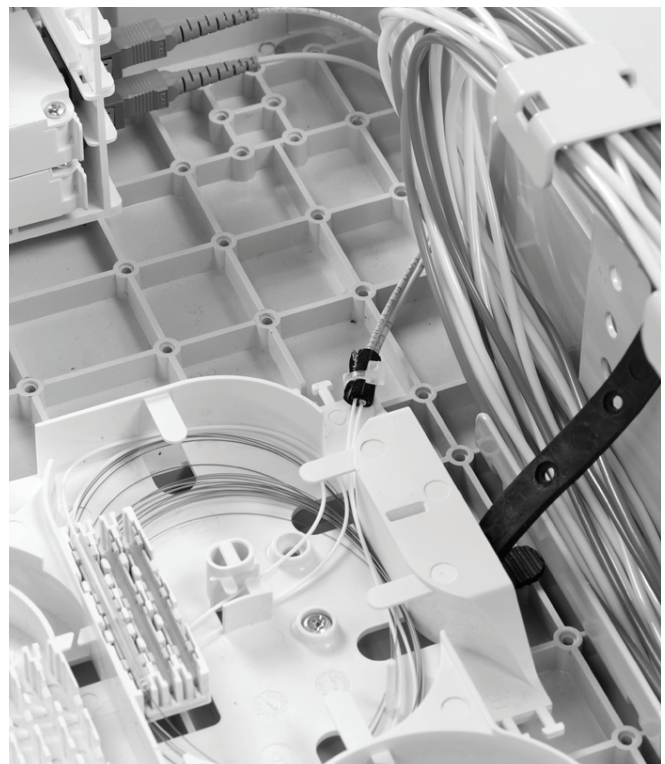
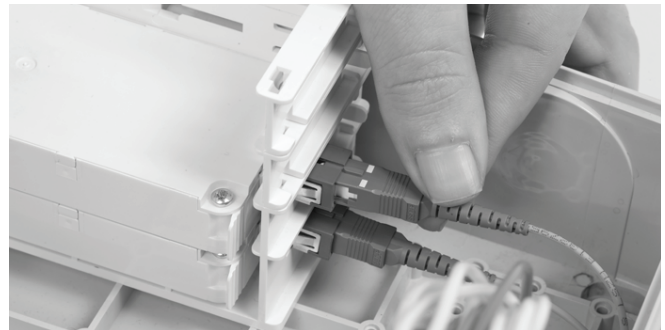
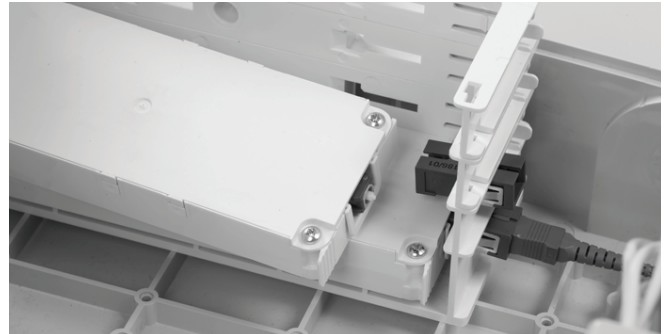
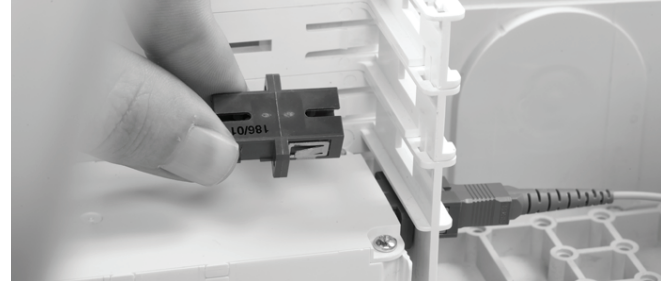

4.4 **In case of splitter modules with integrated adaptors for the incoming signal.** Insert the connector of the pigtail in the adaptor of the splitter and route the pigtail to the base tray. Remove the outer jacket over a distance of 1.2 m and secure with foam and tie-wrap onto the base tray.

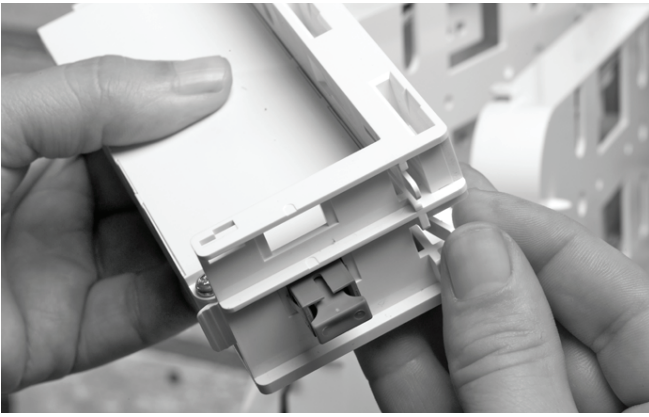

4.5 To release the splitter module out of the splitter holder.

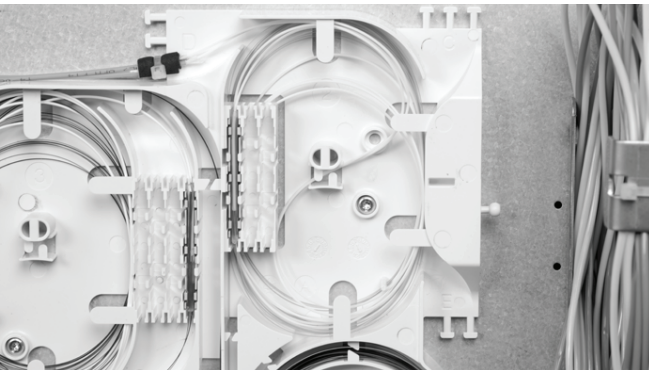
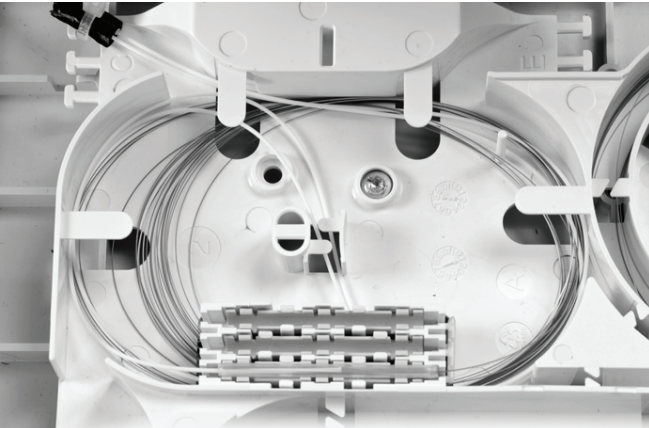

4.6 Splice the incoming of the splitter to the fibers coming from the looped cable. In case of SMOUV, use the insert. Store the overlength in the tray.

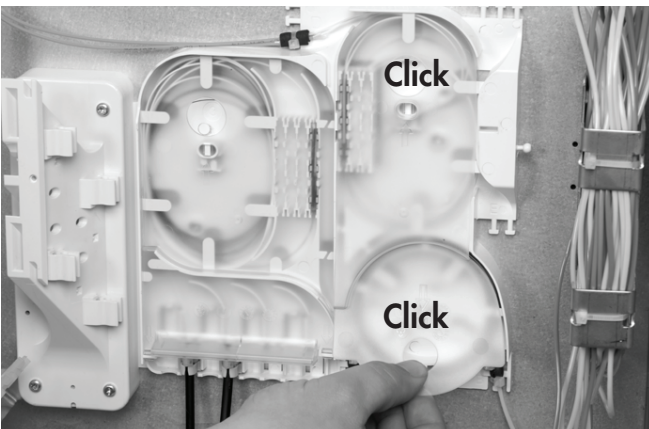

4.7 Install the cover onto the tray.

## 5 Patching trays

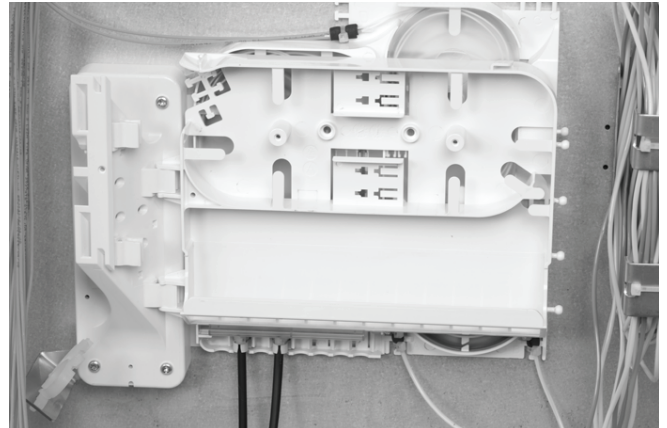
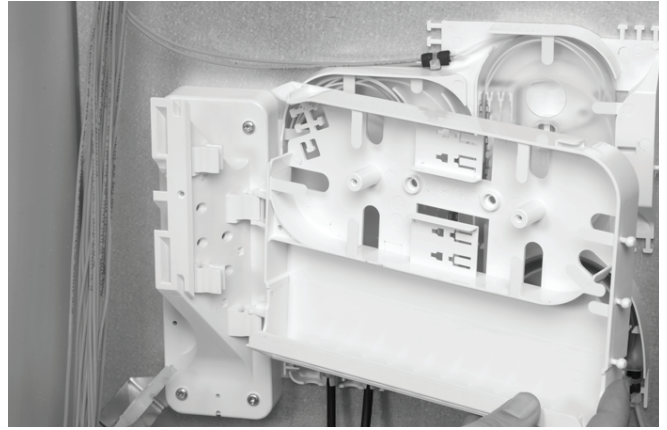

5.1 Install the patch tray onto the tower.

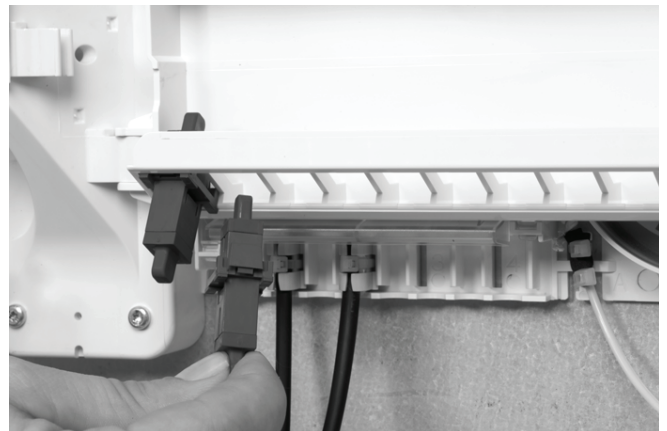

5.2 Insert the adaptor into the designated positions.



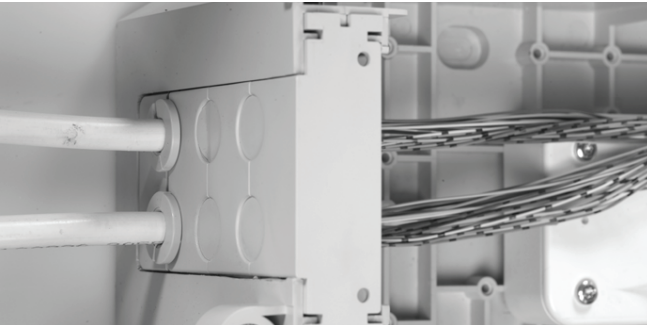
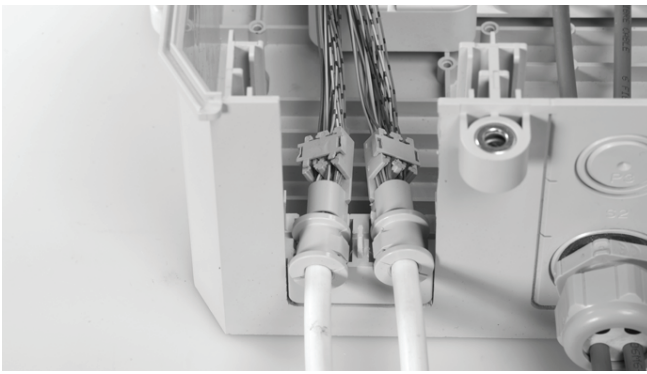

5.3 Install the drop seals and push the PICO cable through the seals. Remove the outer jacket over a length of 1.5 m. Secure the cable onto the bracket with foam and tie-wraps.



5.6 Install the foam at the position on the patch tray and secure with 2 tie-wraps as shown on the picture.

**Mini-PICO (no connectors)**

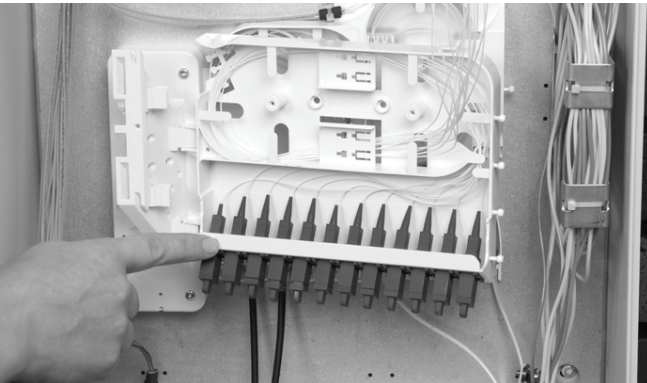

5.4 Install the pigtails and store the overlength in the splice area.



5.7 Install the splice holders onto the patch tray.

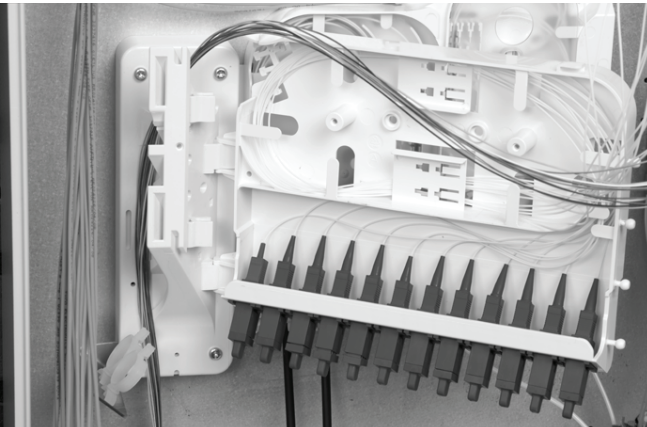

5.5 Route the MINI PICO fibers behind the tower towards the patch tray.

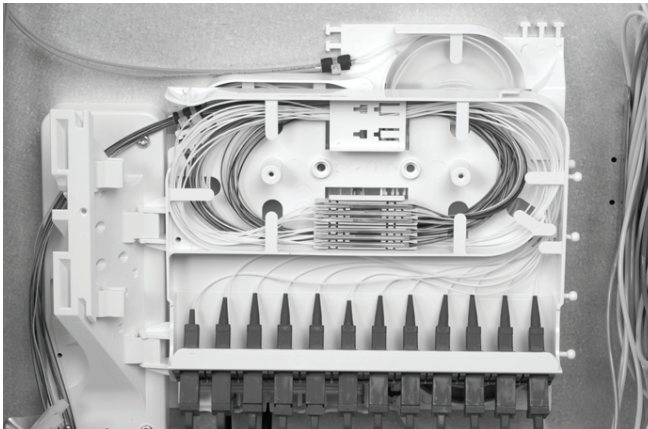

5.8 Splice the MINI PICO fibers to the pigtails and store the overlength in the splice area. Check the orientation of both fibers to avoid crossings.

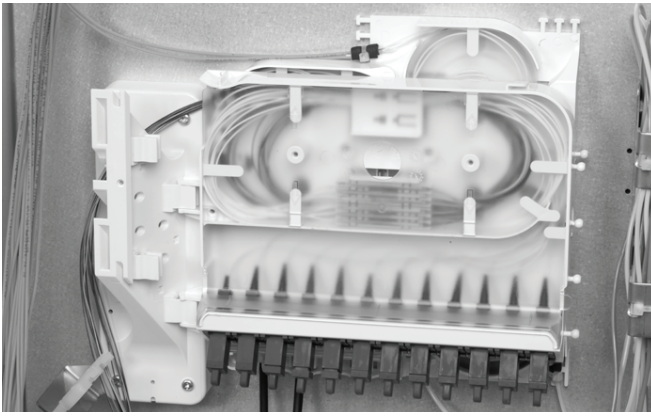

5.9 Install the cover onto the tray.

**Mini-PICO (pre-connectorized)**



5.10 In case of pre-connectorized MINI PICO cable, fibers are also routed behind the tower and secured with foam and tie-wraps onto the tray.

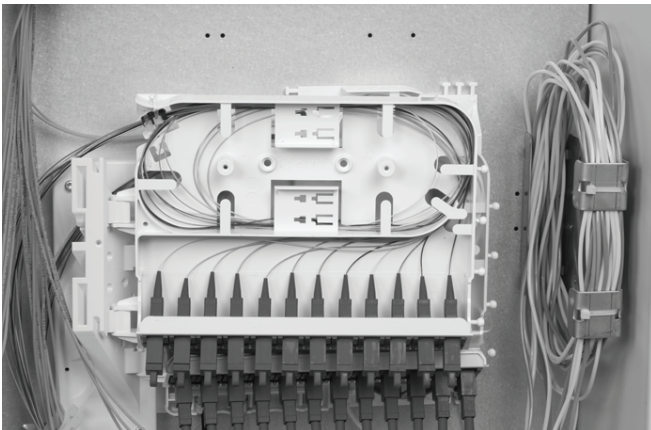

5.11 Store the overlength of the MINI PICO fibers in the splice area.

**6 Routing pigtails from the splitter**

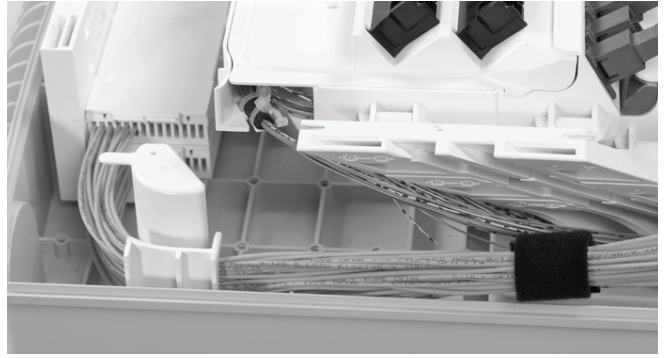

6.1 Route the pigtails through the bend control towards the patch trays. Hook and loop fastener can be used to keep them bundled.

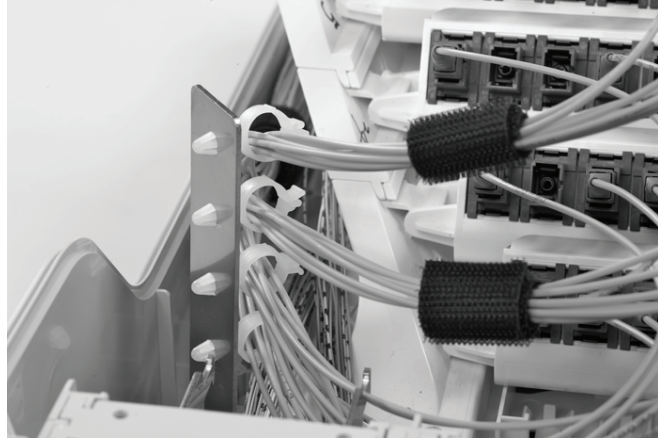

6.2 Route the pigtails through the cable clips for pigtail management. Again hook and loop fastener can be used to keep them in a bundle.

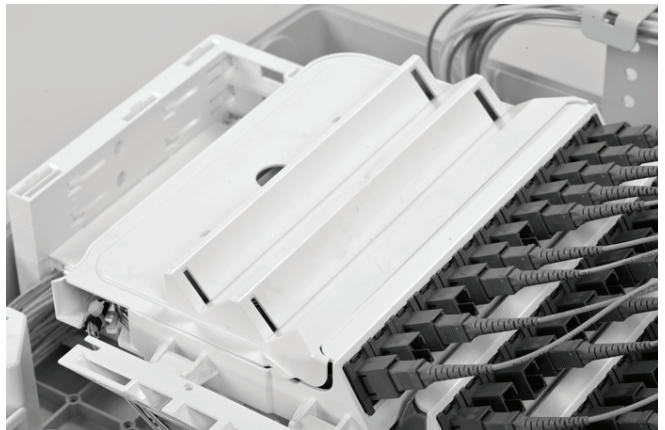

6.3 Install the cover onto the patch tray.



6.4 Secure the patch trays with the rubber flex part, as shown.

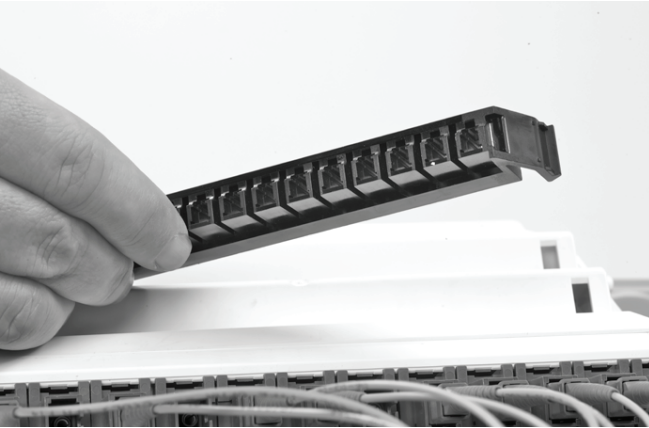

6.5 Park in place for pigtails from the splitter which are not used day 1.

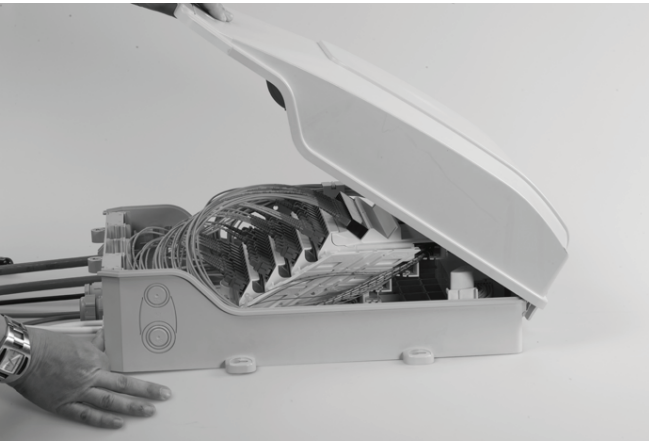

6.6 Close the box.

---

To find out more about CommScope® products, visit us on the web at [www.commscope.com](http://www.commscope.com)

For technical assistance, customer service, or to report any missing/damaged parts, visit us at:  
<http://www.commscope.com/SupportCenter>

© 2017 CommScope, Inc. All rights reserved.

All trademarks identified by ® or ™ are registered trademarks or trademarks, respectively, of CommScope, Inc.

This document is for planning purposes only and is not intended to modify or supplement any specifications or warranties relating to CommScope products or services.

This product is covered by one or more U.S. patents or their foreign equivalents. For patents, see:  
[www.commscope.com/ProductPatent/ProductPatent.aspx](http://www.commscope.com/ProductPatent/ProductPatent.aspx).