

8

7

6

5

4

3

2

1

NOTES:

REVISIONS			
REV	DESCRIPTION	DATE	APPROVED
A	ECR 8000001167: RELEASE TO PRODUCTION PER EAO 600406.	17SEP13 JOY	PL.TANG/LIGWU
D	ECR 8000006791: UPDATE DRAWING WITH LATEST MODEL.	14FEB15 ZW	S.LIU/JIHE
E	ECR 8000008835: ADD CVV65CSX-M.NM & CVV65CSX-3X2.NM.	25JUN15 HWW	S.LIU/JIHE
F	ECR 8000015302: ENDCAP REVISION UPGRADE.	29JUL16 HWN	S.LIU/JIHE
G	ECR 8000028114: UPDATE DRAWING WITH LATEST MODEL..	26JAN18 LXL	S.LIU/JIHE

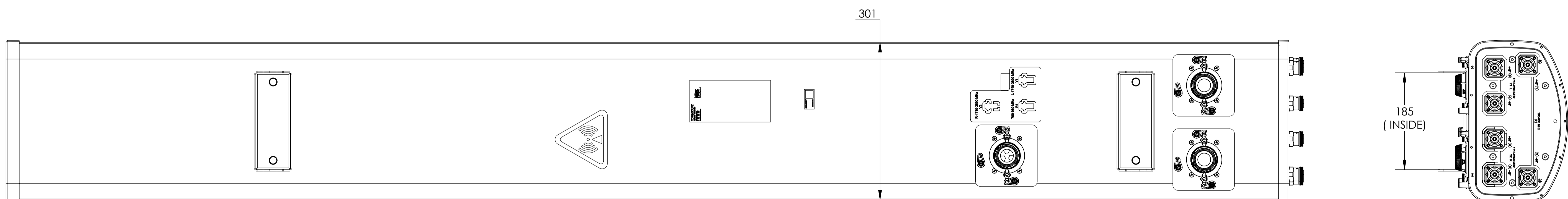
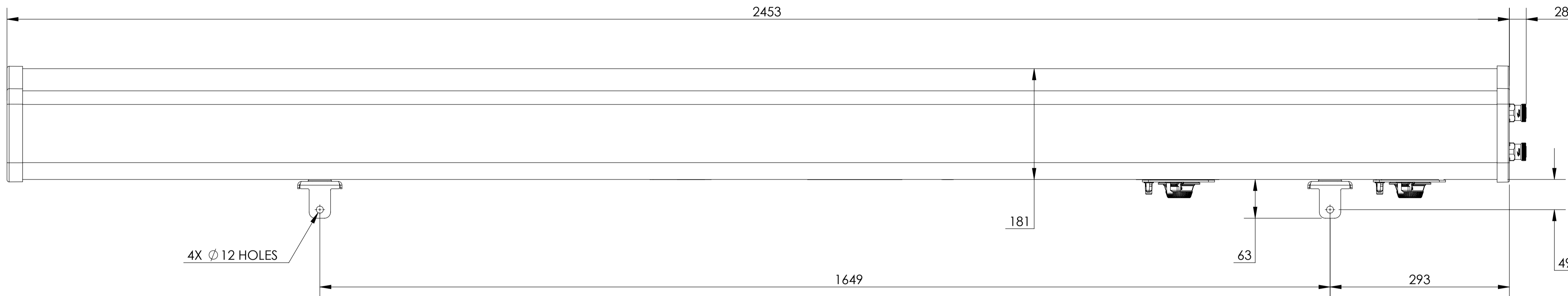

CVV65CSX-M
CVV65CSX-M.NM

THIRD ANGLE PROJECTION

THIRD ANGLE PROJECTION

MATERIAL N/A	DENSITY: MASS:	UNLESS OTHERWISE SPECIFIED DIMENSIONS ARE IN MILLIMETERS INTERPRET PER ISO STANDARDS HANDBOOK, TECHNICAL DRAWINGS, VOLUMES 1 & 2, THIRD EDITION (2002)	WESTCHESTER, IL. 60154 U.S.A.					
FINISH N/A	TOLERANCES 0 PLACE X± 1 PLACE .X± 2 PLACE .XX± ANGLES ± ALL SURFACES ✓	THIRD ANGLE PROJECTION 	PRODUCT DRAWING					
DRAWN BY JOY 17SEP13 ECN 8000028114-O		SIZE A1	CAGE CODE 84147	DOCUMENT NO. CVV65CSX-M-L				
AUTH. GROUP 23		MODEL	DRAWING		SHEET			
NOTICE: These drawings and specifications are the proprietary property of ANDREW CORPORATION and may be used only for the specific purpose authorized in writing by Andrew.		VERSION 07	STATUS RE	REVISION H	VERSION 06	STATUS RE	REVISION G	SHEET 1 OF 3

8

7

6

3

2

1

8

7

6

5

4

3

2

1

D

D

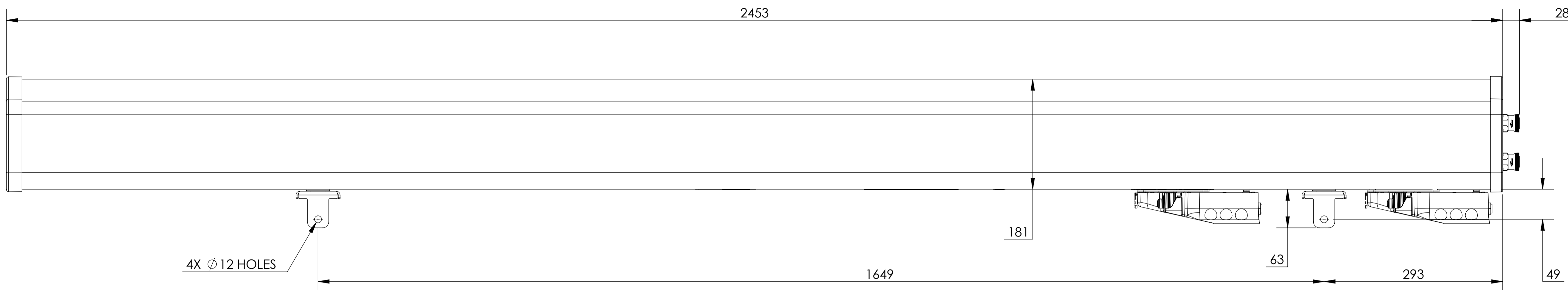

C

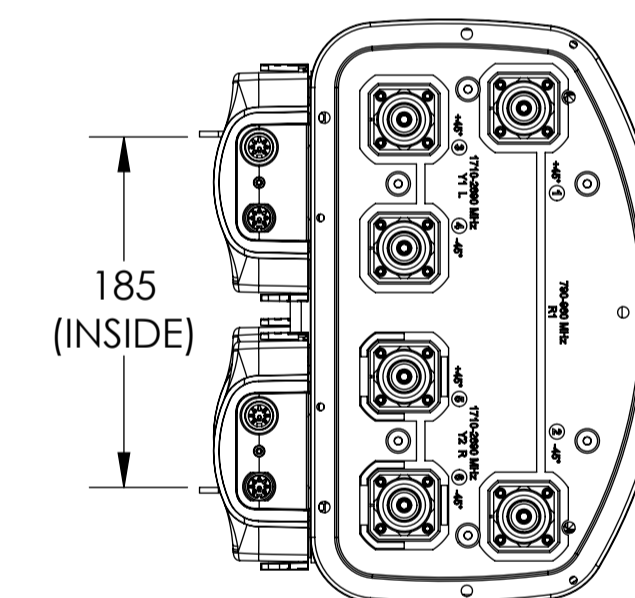
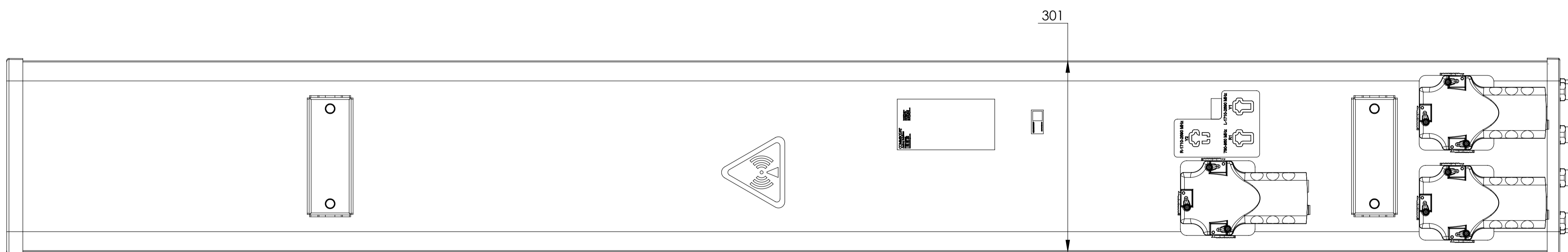

B

CVV65CSX-3X2
CVV65CSX-3X2.NM

A

A

ANDREW WESTCHESTER, IL. 60154
U.S.A.

PRODUCT DRAWING

THIRD ANGLE PROJECTION



SIZE **A1** CAGE CODE **84147**

DOCUMENT NO. **CVV65CSX-M-L**

NOTICE: These drawings and specifications are the proprietary property of ANDREW CORPORATION and may be used only for the specific purpose authorized in writing by Andrew.			
VERSION	STATUS	REVISION	SHEET
06	RE	G	2 OF 3

8

7

6

THIRD ANGLE PROJECTION

3

2

1

8

7

6

5

4

3

2

1

D

D

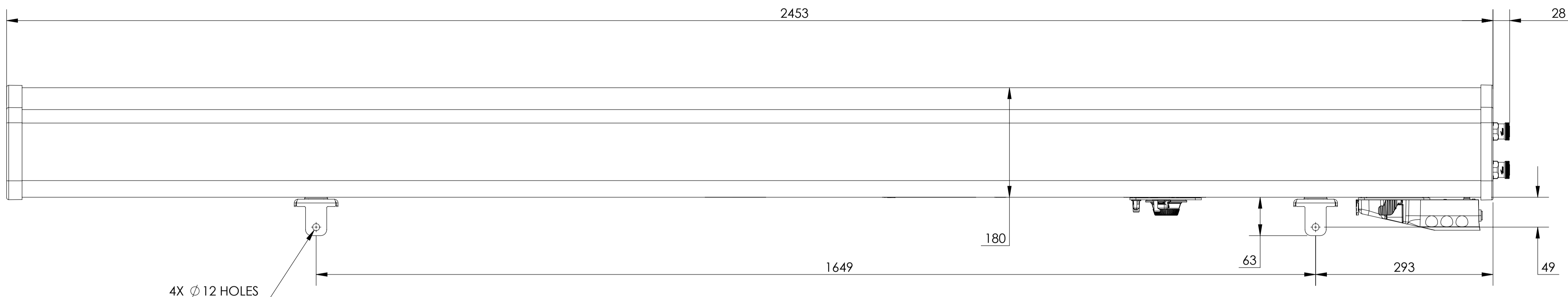

C

THIRD ANGLE PROJECTION

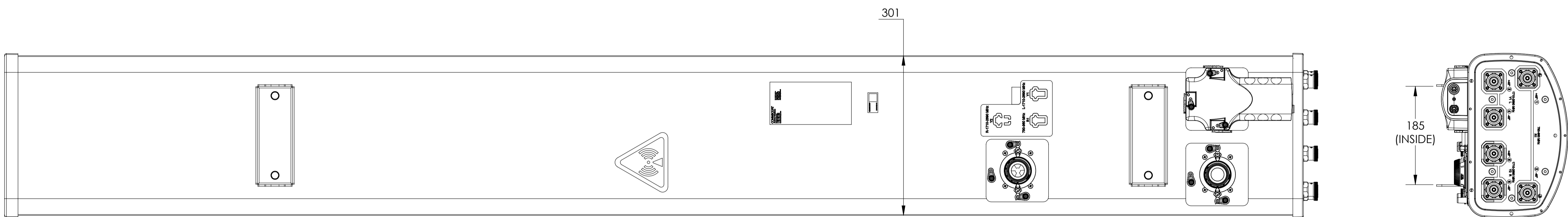

B

CVV65CSX-MM2

A

A

ANDREW WESTCHESTER, IL. 60154
U.S.A.

PRODUCT DRAWING

THIRD ANGLE PROJECTION



SIZE **A1** CAGE CODE **84147**

DOCUMENT NO. **CVV65CSX-M-L**

NOTICE: These drawings and specifications are the proprietary property of ANDREW CORPORATION and may be used only for the specific purpose authorized in writing by Andrew.

VERSION	STATUS	REVISION	SHEET
06	RE	G	3 OF 3

8

7

6

THIRD ANGLE PROJECTION

3

2

1