

Fiber Optic Splice Closure

FOSC 450-ab-c-dd-e-fgh

- a = Closure size
- b = Number of cable ports (6 for B-size)
- c = Number of cable ports for which termination hardware is provided (typically all ports or 2 ports)
- dd = Capacity or type of splice tray (12, 24, NT [no trays])
- e = Number of trays pre-installed (1 or 0 [NT] is standard)
- f = Basket type (N=none or B)
- g = Number of ground feed-thru lugs (0 or 3)
- h = Valve for flash test (V = Yes [standard], N = No)

1.0 General Product Description

The FOSC 450 fiber optic splice closures use compressed-gel cable seals to environmentally seal fiber cable splice points.

The maximum single splice capacity of the FOSC 450 B6 closure is 144 with 24 splices stored on six trays. The maximum mass fusion splice capacity is 288, only four trays are needed.

A larger FOSC 450 D6 closure is also available. Splice capacities for the D size are 576 for single splicing and 1152 for mass splicing.

Note: Cable blocking is not recommended in this closure due to the space constraints. If cable blocking is used, follow the special instructions in "D/Gel Cable Block" installation instructions.

2.0 Kit Contents

- Dome and clamp
- Base and o-ring
- Metal slack basket (optional)
- Gel end-piece
- Velcro strap
- 4 Gel end-piece plugs
- 2 or 6 Cable strain relief holders and cable clips
- Hose clamps
- 6 Small and 2 large strength member attachment brackets with lugs
- 3 Bond clamps (3" long) -- optional
- 3 Braided grounding straps -- optional
- 12 Small tie wraps
- 1/4" Nut driver to install hose clamp
- Installation Instructions

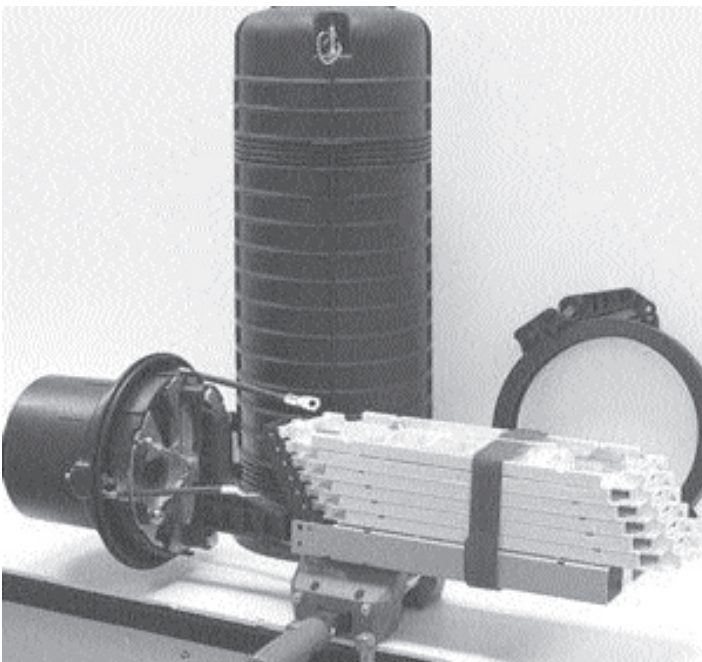

Other Accessory Kits:

- FOSC-ACC-B-Tray-12, 16 and 24 (tray kit)
- FOSC-450-Cable-Term-4-N or FOSC-450-Cable-Term-4-G (grounding). Contains 4 replacement cable termination components, can be ordered with or without grounding.
- FOSC-ACC-B-Bracket
- FOSC-ACC-450-Workstand
- FOSC-ACC-Wall/Pole-Mount
- FOSC-ACC-Aerial-Clamp
- FOSC-ACC-Aerial-SWVL-Mount
- FOSC-ACC-Aerial-Clamp
- FOSC 450 Small/Seal-4 Cable Kit
- FOSC 450 Small/Seal-3 Cable Kit

IMPORTANT: Store unused components and installation instructions in bag and keep inside closure for future cable terminations. If these parts are lost, you will need to order the above 450 B/Gel cable kit to terminate future cables.

3.0 Open Closure

Note: Before opening a sealed closure make sure all air is bled from the closure, use the valve in the dome to do this.

1. Remove the dome to base clamp. Pull the clamp slightly to the side and lift the clamp handle, use the feet of the clamp to pry against the two posts to spread the clamp open. Open one side of the clamp all the way and pull it back on itself quickly to remove it from the dome and base (Fig. 1).

2. Remove the dome from the base of the closure.

Note: Using a FOSC ACC 450 closure workstand makes installations easier (PML #941802-000).

3. If a gel seal is already installed loosen the gel seal by turning the tail of the seal counter-clockwise until the seal is loose. Unsnap each of the two wire clips and remove the base from the metal frame. (Fig. 2)

4.0 Cable Preparation

Note: The maximum slack storage lengths listed in the chart at right will be limited more with higher count Loose Buffer Tube (LBT).

Note: Cable range is .35" to 1" diameter.

IMPORTANT: Small round or flat cable installations – If cables are less than 0.35" in diameter or flat drop style, an additional step is required for cable sealing in the port. In this case the cable diameter must be build up to the minimum 0.35" diameter. In addition, if multiple small cables like these are to be installed in a single port, it is imperative that gel is applied between the cables before installing them into the gel port. See FOSC 450 Small/Seal-3 or -4 Cable Kit installation instructions or FOSC 450 Single Small Cable Kit installation instructions for further details.

Use these accessory kits to seal multiple small cables in a single port:

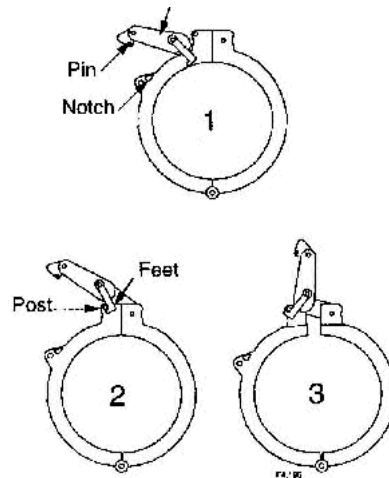
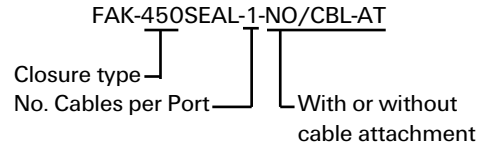

Fig 1



Fig 2

4.1	Loose Fiber		
	Loose Buffer Tube (LBT)	Midspan End	55"-72" *36"-48
	* Minimum length when routing directly to the tray or cutting dead to the field		
	Central Core Tube (CCT)	Midspan End	52"-74", 84" 36"- 48", 58"
4.2	Ribbon Fiber		
	Central Core Tube (CCT)	Midspan End	52"-75" 70"

Note: If mass fusion splicing of ribbons is to be done, the ribbons must be routed to the slack basket first. Do not route these ribbons directly to the tray unless they will be de-ribbonized for single splicing.

1. Ring cut and remove the outer cable sheath and shield (if present). Remove the fiber yarns and cloth, trim at ring cut. Clean fiber.

Note: Leave a short length of ripcord at each ring cut.

2. Before cutting the strength members, you must determine which Strength Member Bracket (SMB) and lug will be used. Select the lug that fits over the strength member most easily.

Note: The smaller SMB and lug can be used on most cables, but cables with large strength members may require the large SMB and lug (i.e. 144 LBT cable). The large SMB should not be used in the top two ports (3 & 4) of the metal frame (Fig. 5).

3. After determining which strength member bracket (SMB) and lug will be used, cut the strength member(s) to length. Measure from the ring cut.

Strength Member Bracket (SMB)	Cut Length of Strength Member
Large	2-1/2"
Small	2"

Note: If using Central Core Tube (CCT) cable and entering through the bottom two ports (5 & 6), ring cut and remove the CCT 6" from the ring cut(s). If cables enter through the upper ports, ring cut the CCT 1 1/4" from the ring cut.

4. Determine which port of the metal frame the cable will be installed (Fig. 5). Once the cable termination hardware is installed onto the cable sheath, the assembly slides into the metal frame. Observe the orientation needed with the cable retention hardware to allow easy installation without twisting the cable.

Note: If grounding is required, the ground wire should be positioned on the cable so it clears the tray support tower (ports 3, 4, 5 or 6). The black plastic tray support tower is on the other side of the metal frame above (Fig. 5).

5. Either tab or pull the ripcord 1" past the ring cut. Crimp the supplied ground wire onto the sheath and shield. For CCT cable, tab between the strength members, for cables entering on the right attach ground to the right side of tab and for left cable attach to the left side of tab. Wrap the installed ground wire connection and sheath with two or three wraps of vinyl tape.

Note: Do not use a braided or stranded ground wire when installing a ground through a port on any CommScope fiber optic splice closure. CommScope requires a solid, bonded ground wire to prevent a leak path and create a proper seal.

6. Install the SMB into the smaller black cable attachment section. (Fig. 6)

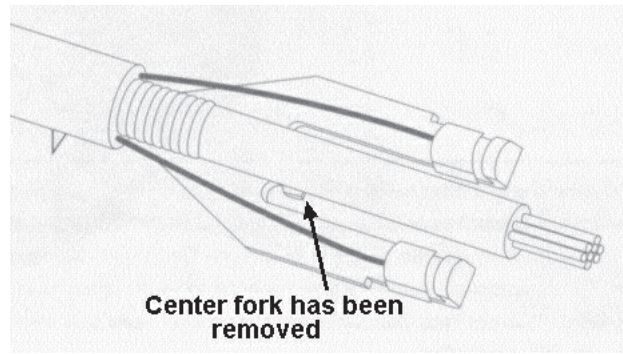

Fig 3

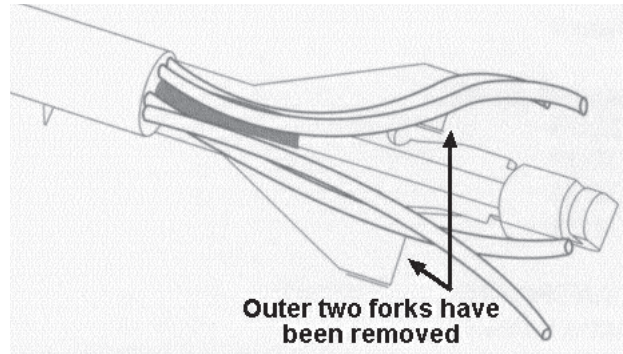

Fig 4

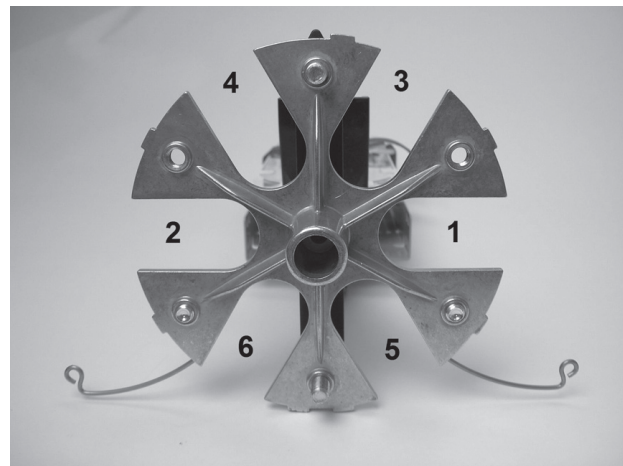

Fig 5

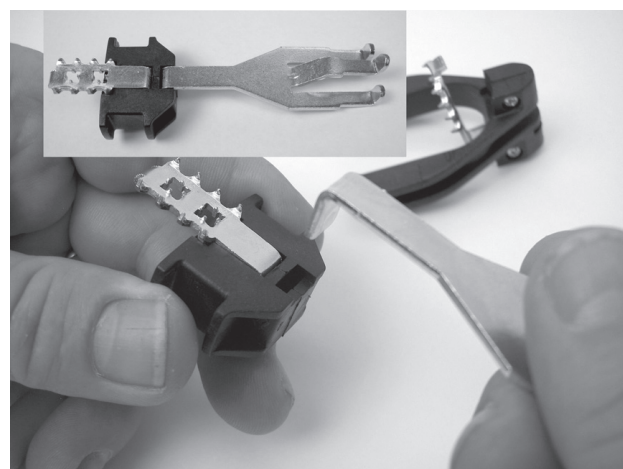
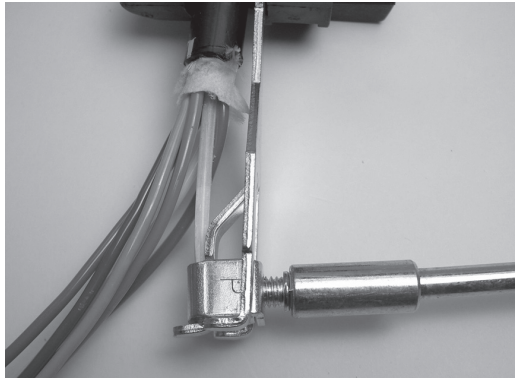

Fig 6

Fig 7



7. Install the lug over the strength member(s) and SMB - tighten screw. The screw should push down on the SMB, not the strength member itself. (Figure 7)

Note: The unused fork section(s) of the SMB can either be bent back or cut off to eliminate interference with fiber tubes (Fig. 4).

Note: When LBT cable is used divide the tubes at the top before installing the SMB. This will provide a path for the strength member to be connected to the SMB (Fig. 7).

8. With appropriate size hose clamp handy, install both sections of the cable retention and SMB around the cable. Install and tighten the hose clamp such that the teeth fully seat into the cable assembly. Do not overtighten the clamp to the point that it deforms. A 1/4" nut driver is supplied in the kit to tighten the hose clamp (Fig. 8).

Note: If a ground wire is present position the assembly as close to the ground as possible (towards the ring cut). The end of the strength member should be just inside the end of the strength member fork so the lug captures the end of the strength member. (Figure 8)

Fig 8

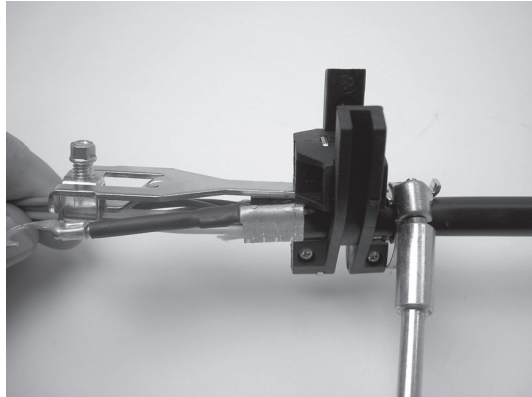

5.0 Cable Installation

IMPORTANT RULES

- Slide the closure base (small end first) over the cables to be installed in the closure before attaching cables to the metal frame (Fig. 9).
- Midspan and/or main cables are typically installed in the lower ports of the closure and routed to the slack basket for slack storage and/or continue to the tray for splicing.
- Branch off or drop cables are typically installed in the upper ports of the closure and routed directly to the trays, see R4 for Central Core Tube cable (CCT).
- CCT cable tubes entering the lower two ports of the closure can be routed directly to the slack basket or if no slack basket exists, to the lower non-hinging tray. When routing central core tubes to a hinged tray, spiral tubing must be used.

Fig 9



1. Slide the cable and cable attachment assembly into the frame port until it locks into position. If required, the cable attachment can be loosened and re-positioned for easier alignment with the port. (Figure 10)

Note: Ground wires can now be attached either to an external ground, or to a braid strap, to provide continuity. Do not use a braided or stranded ground wire when installing a ground through a port on any CommScope fiber optic splice closure. CommScope requires a solid, bonded ground wire to prevent a leak path and create a proper seal.

Fig 10

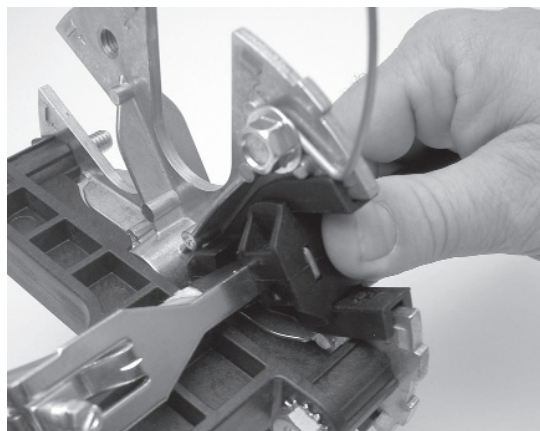

Note: To remove cable attachment assembly, tilt the assembly over the retention tabs and pull firmly.

6.0 Cable Routing

Note: *If this is a new closure, remove any installed trays that might make fiber routing easier. Install trays as you go. Refer to section 4.0 for cable preparation.*

Go to:

- 6.1 for Loose Buffer Tube Cable
- 6.2 for Central Core Tube Cable

6.1 Loose Buffer Tube Cable Installation

1. Review IMPORTANT RULES from pg. 4.

Note: *If the LBT cable contains the older style stiff LBT's, it will be necessary to ring cut the LBT 1-1/2" from the ring cut and install transportation tubes over the LBT for routing.*

2. Route loose buffer tubes (LBT) either to the basket for slack storage or to the tray for splicing. LBT's can be routed directly from the port to the tray or from the basket to the tray(s).

Note: *If installing a midspan and need to splice only part of the fibers in a loose buffer tube (LBT), go to step 6.*

3. Mark the LBT and ring cut as shown (Fig. 11). Remove LBT and clean fibers.

4. Secure the LBT to the tray with tie-wraps.

Note: *Felt wrap can be installed onto LBT's to provide better resistance to pull-out prior to tie-wrapping tubes to the tray.*

5. Splice and organize fibers on the tray. Once all splicing is complete, go to section 7.0

6. Route the designated uncut LBT to the tray as shown below and mark tubes. The LBT will be routed and secured on both right and left sides of the tray. Mark the tube as shown. (Fig. 11).

7. Shave the LBT back to each marks on the tube and remove section of LBT.

8. Secure each end of the LBT to the tray and clean the fibers.

9. Route drop fibers to be spliced to the same tray. Secure tube(s) with tie-wraps.

10. Splice and store the designated fibers into the tray first .

11. Store the uncut fibers last. This will allow easy access to the uncut fiber if they need to be spliced at a later time. Once all splicing is complete, go to section 7.0



Fig 11

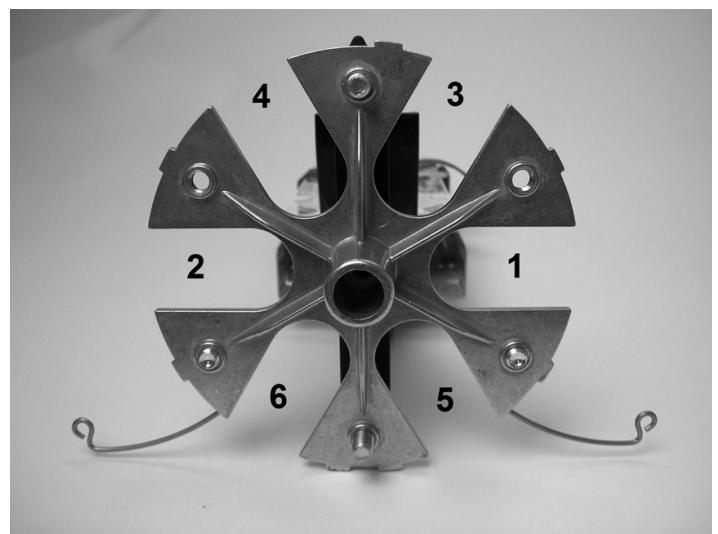

Fig 12

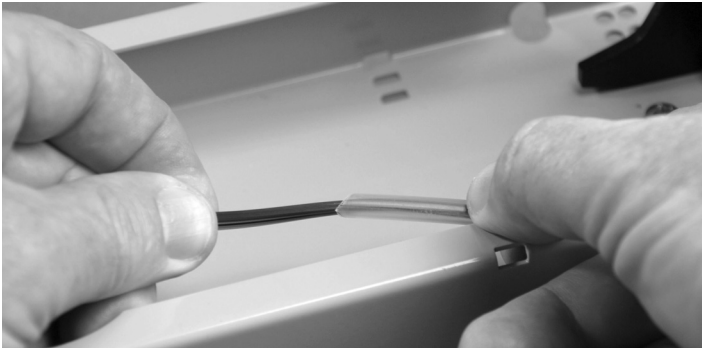

Fig 13

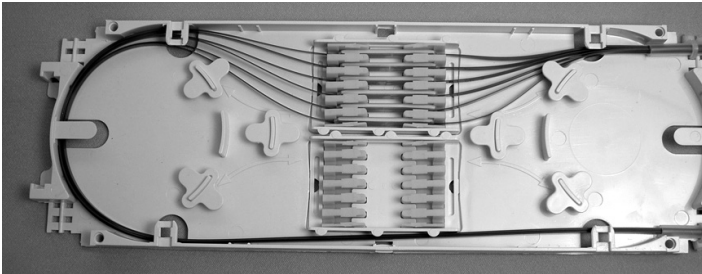

Fig 14



Fig 15

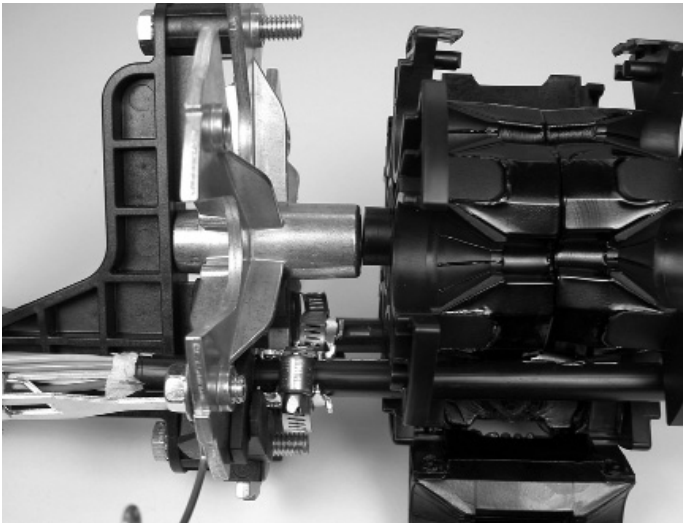

Fig 16

6.2 Central Core Tube Cable Installation

1. If cable(s) enter through the bottom two ports (5 & 6), core tubes can be routed directly to the slack basket or non-hinging bottom tray and secured with tie-wraps - do not over tighten. The core tubes should already be cut to 6" length.

If cable(s) enter through the middle or upper ports (1, 2, 3, or 4 – See Figure 12) hold the section of (large) spiral wrap up to the ring cut of the cable and route it to the tray or basket location where fibers need to go. Allow a generous length for tray hinging, and cut the spiral tubing to length and install it over the fibers and central core tube (CCT). Make sure the spiral tube is pushed all the way up between the strength members and CCT. This will help secure the spiral wrap. Also, make sure there is enough length of tubing on the tray, or basket, for two tie-wraps - do not over tighten.

Note: Generally speaking, ribbons should be routed to the slack basket and not directly to the trays. Ribbon slack should not be stored on the tray. Do not route ribbons directly to the tray unless the ribbons will be de-ribbonized for single splicing.

Note: Go to section 6.3 for Central Core Tube Ribbon Cable.

2. If fibers are on the tray, splice and organize fibers. Once all splicing is complete go to section 7.0 If fibers are in the slack basket, continue to step 3.

3. Select fiber(s) to be cut or routed.

Note: Selected midspan fibers can be cut in the middle of the loop to splice to either end, but if more length is needed, cut offset from midpoint (short end fibers will be dead to the field).

4. Fibers will be transported to the opposite side of the basket and routed to appropriate trays using the transportation tubes. Attach transportation tubes to the basket. Tubes can be identified at both ends with feed (blue) and distribution (white) labels. Take transportation tube behind the tray tower and attach to tray with tie-wraps.

5. Splice and organize fiber. Once all splicing is complete, go to section 7.0

6.3 Central Core Tube Ribbon Cable

1. Layout and separate ribbons. Select ribbons to be cut or routed.

Note: Selected midspan ribbons can be cut in the middle of the loop to splice to either end. This will allow 15" to 24" for splicing. If more length is needed, cut offset from midpoint (short end ribbons will be dead to the field).

2. Ribbons will be transported to the opposite side of the basket and routed to appropriate trays using the ribbon transportation tubes (green rubber band group). Attach transportation tubes to the basket leaving 6" in the basket. Tubes can be identified at both ends with feed (blue) and distribution (white) labels. Route the transportation tube behind the tray tower and attach to tray with tie-wraps.

Note: Arrange the order of ribbons before inserting them into the transportation tube. This will eliminate crossing of ribbons on the tray.

3. Feed arrangement of designated ribbons (groups of six) into the tubes in the basket and pull ribbons through transportation tubes onto the tray- leaving a small loop in basket. Ribbons on one side of transportation tube may need to be oriented in an opposite order to prevent crossover of ribbons on the tray. (Figure 13)

4. Pull enough ribbon length through the transportation tubes to complete splicing.

5. Splice ribbon ends, allow generous bend when routing (six splices per tray recommended). (Fig. 14)

6. Ribbons can be pulled back into the basket. Pull all the ribbons in the group at the same time.

Note: Do not store ribbon loops on the tray.

7. Store slack ribbon length in the slack basket and hold down stored ribbons with tie-wraps, leave the tie-wraps loose to avoid unnecessary pressure in the ribbons. Once all splicing is complete, go to section 7.0

7.0 Gel End-Piece Installation

1. Make sure the gel end piece is not already compressed. Turn the "tail" of the gel end piece counter clockwise to ensure that the seal is in the un-compressed position. Squeeze the gel end piece to unlatch and open each half one at a time. (Figure 15)

2. Install the gel end piece around the cables. Position it against the spacer on the metal frame. Snap both halves of the gel end piece together. (Figure 16)

3. **Important:** Insert one port plug in each unused port (Fig. 17)

4. Slide the base up and over the gel end piece, make sure the wire clips and ground wires are back out of the way. Make sure to line up the arrow on the base (Figure 18) with arrow on the top of the frame (Figure 19).

Once the base is in position, snap the wire clips into the base by pushing firmly on the clips (Figure 20).

5. Connect any ground wires attached to the cables to the nearest ground wire that leads to the ground feedthroughs in the base.

6. Turn the "tail" clock-wise until it dead ends at the physical stop or becomes tight (Figure 21). A screwdriver can be installed through the hole in the tail to tighten the seal. Hold the screwdriver tightly so it does not come out.

7. Place a large tie-wrap around all the cables near the end of the tail.

Once the plugs are installed and the gel end piece is tightened go to section 8.0.

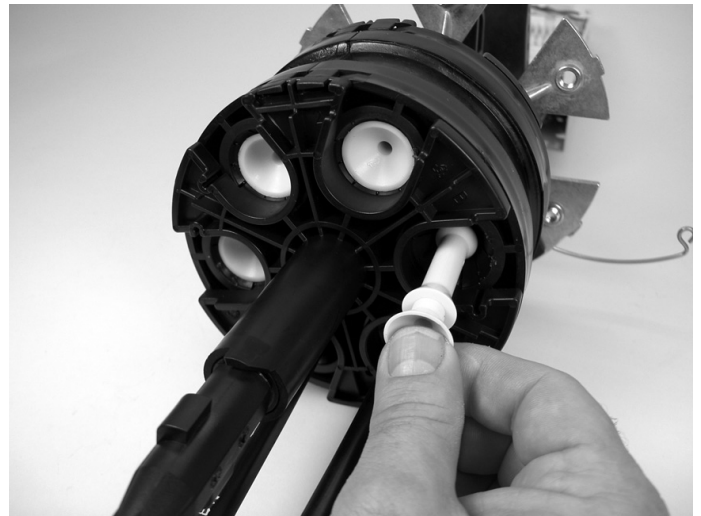

Fig 17

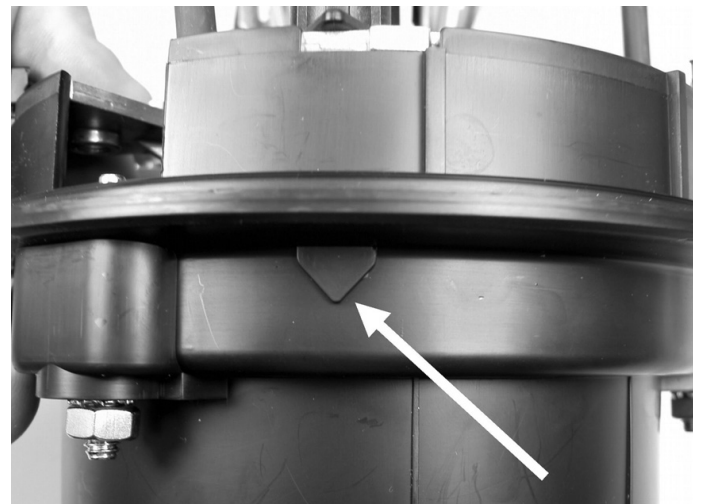

Fig 18

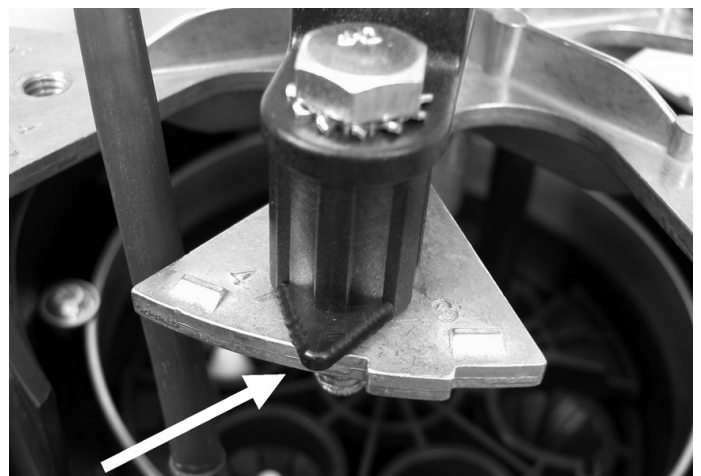

Fig 19

8.0 Close the Closure

1. Important: Place all unused cable termination hardware in the bag and store in closure for future cable terminations.
2. Check to make sure the "O" ring is positioned properly on the rim of the base.
3. Install the dome onto the base, align the arrow on the dome with the arrow on the base. The dome should sit flush on the base.
4. Install clamp around dome/base interface. Use the feet of the clamp handle to close the gap in the clamp (Fig. 22).
5. A security lock or tie-wrap may be inserted through the round holes in the handle and clamp to lock the closure.

8.1 Test Seals

Flash test the closure to 5 psi. Thoroughly soap seal to check for integrity.

Important: After flash testing, bleed all pressure from the closure through the valve

9.0 Mounting Closure

The FOSC 450 B6 kit can be mounted to an aerial strand, to a wall, or to a pole using these supplementary kits:

Aerial Mount
FOSC-ACC-AERIAL-CLAMPS
(PML #663259)

Pole/Wall Mount
FOSC-ACC-WALL/POLE-MOUNT
(PML #C82508-000)

Technical Assistance Center (TAC)
Tel.: 800.830.5056
Email: TAC.Americas@commscope.com
www.commscope.com

FOSC 450, CommScope, and the CommScope logo are trademarks.

The information given herein, including drawings, illustrations and schematics which are intended for illustration purposes only, is believed to be reliable. However, CommScope makes no warranties as to its accuracy or completeness and disclaims any liability in connection with its use. CommScope's obligations shall only be as set forth in CommScope's Standard Terms and Conditions of Sale for this product and in no case will CommScope be liable for any incidental, indirect or consequential damages arising out of the sale, resale, use or misuse of the product. Users of CommScope products should make their own evaluation to determine the suitability of each such product for the specific application.

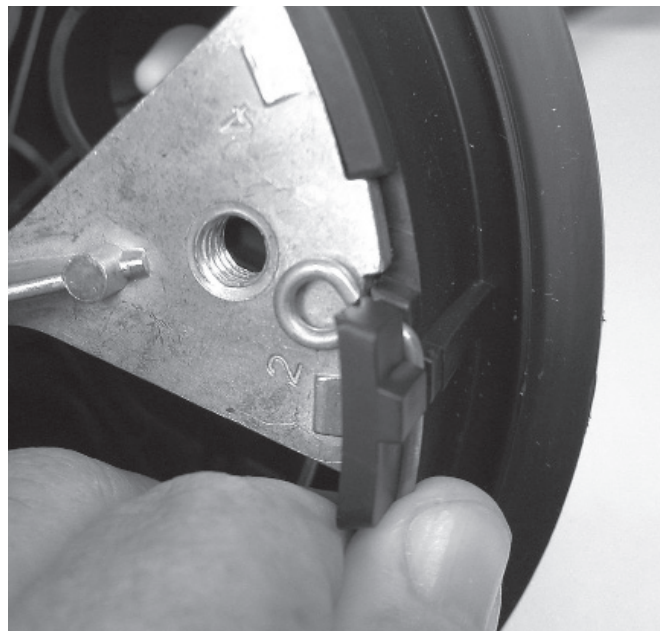

Fig 20

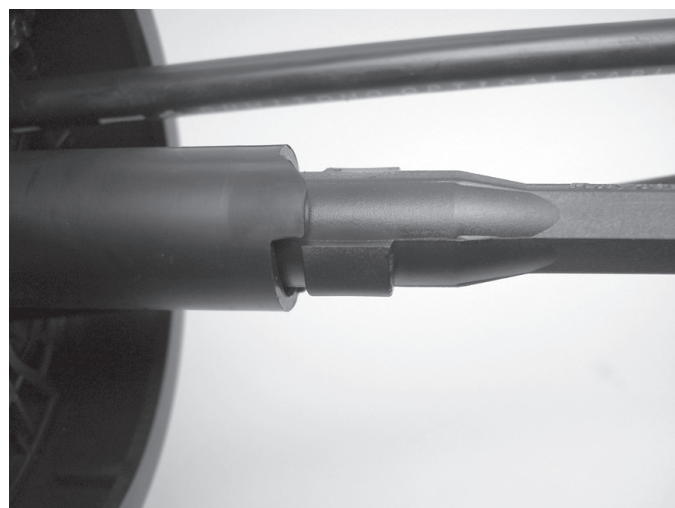

Fig 21

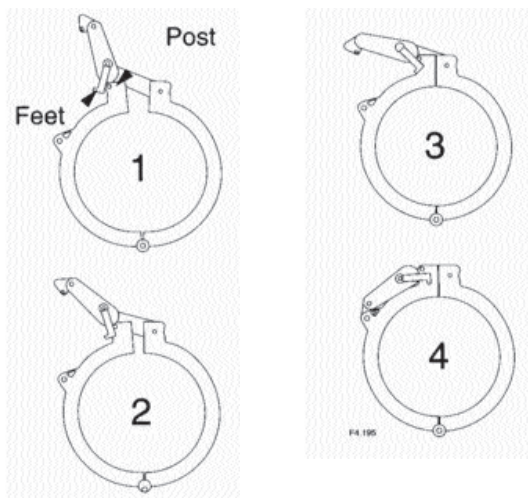

Fig 22