

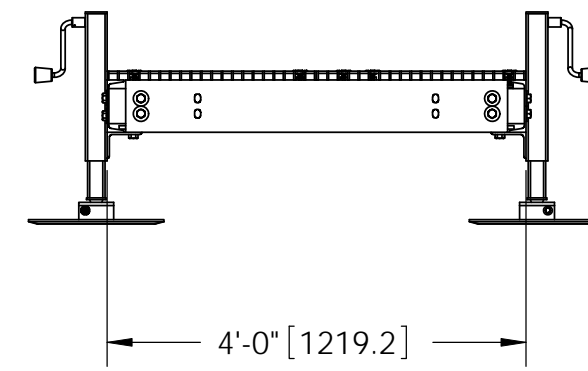

ITEM	PART NO.	DESCRIPTION	QTY.	WEIGHT
1	EQ-P6C0412-B	4' X 12' Equipment Platform	1	744.89 LBS
2	EQ-P-AL	ADJUSTABLE LEG KIT FOR EQ-P SERIES	6	56 LBS

REVISIONS				
REV.	ZONE	DESCRIPTION	BY	DATE
A		INITIAL RELEASE	DRR	03/17/11

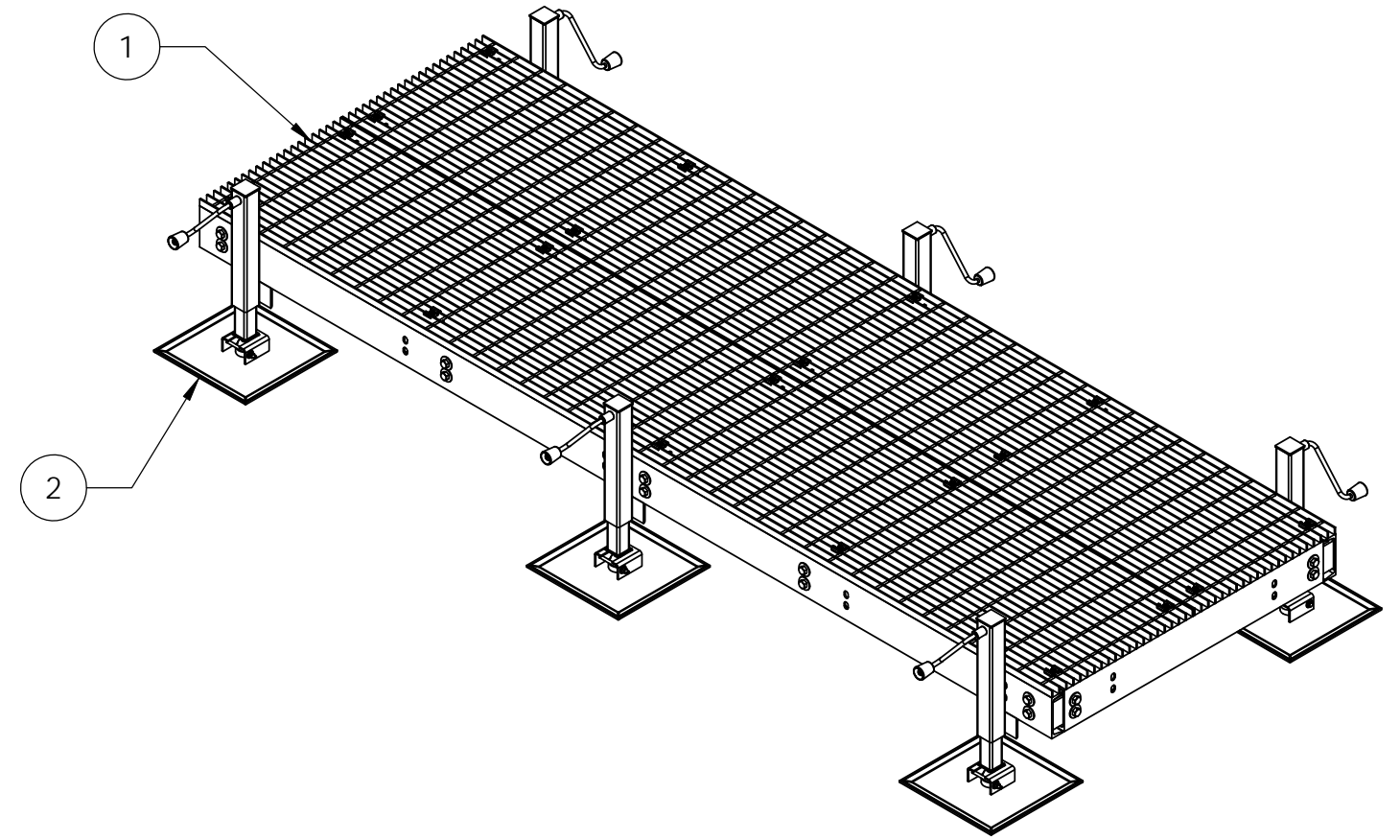
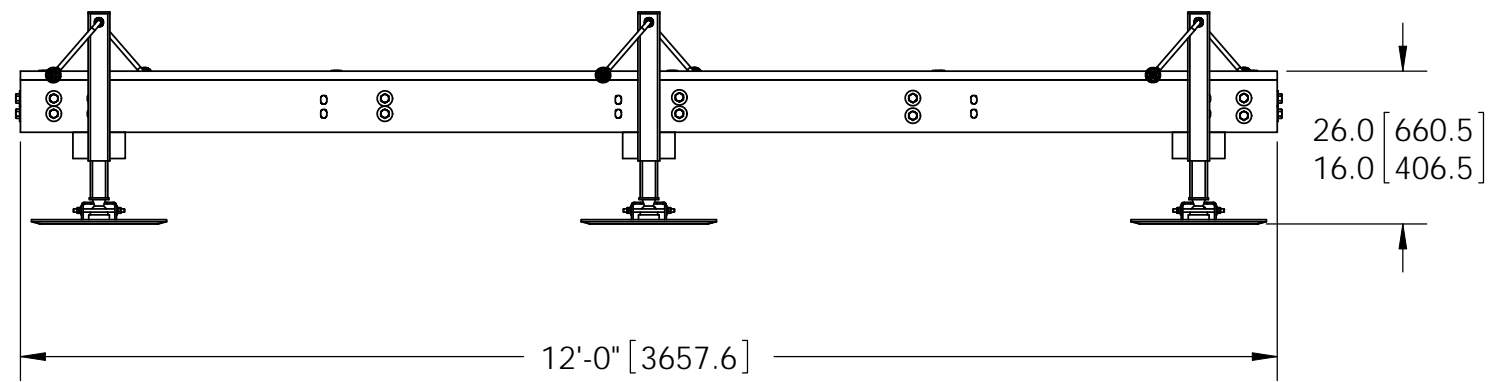
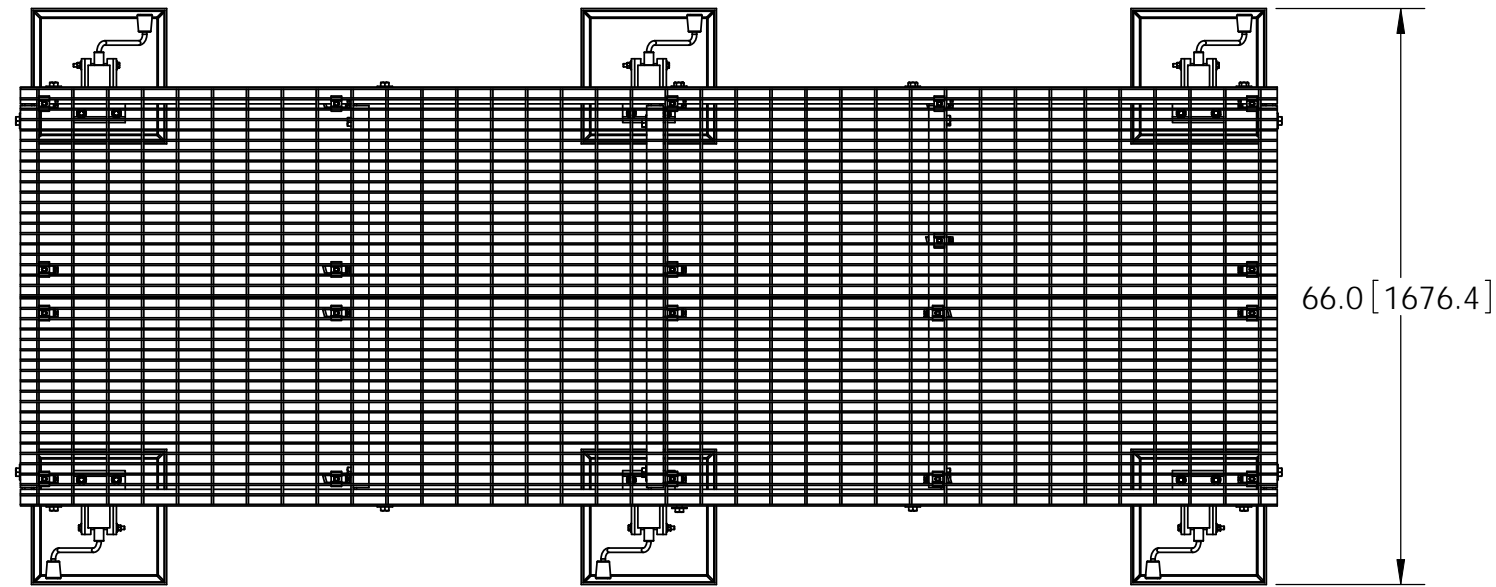

NOTES:
1. ALL METRIC DIMENSIONS ARE IN BRACKETS.

<small>These drawings and specifications are the proprietary property of ANDREW CORPORATION and may be used only for the specific purpose authorized in writing by Andrew Corporation.</small> ALL DIMENSIONS ARE IN INCHES U.O.S. TOLERANCES UNLESS OTHERWISE SPECIFIED: .X = ± .12 ANGLES ±2° .XX = ± .06 FRACTIONS ±1/32 .XXX = ± .03 REMOVE BURRS AND BREAK EDGES .005 DO NOT SCALE THIS PRINT	DRAWN BY: OGG	SHEET: 1 of 1	PART NUMBER: EQ-P6C0412-AL
	CHECKED BY: TP	SCALE: NTS	DESCRIPTION: 4' x 12' Equipment Platform, 6 AL
	DATE: 02/17/10	MATERIAL: A36, A568	DRAWING TYPE: ASSEMBLY DRAWING
	REVISION: A	FINISH: GALV A123 WEIGHT: 1080.89 LBS	 WESTCHESTER, IL. 60154 U.S.A.