

N Connectors

for HELIAX® LDF1-50 Coaxial Cable

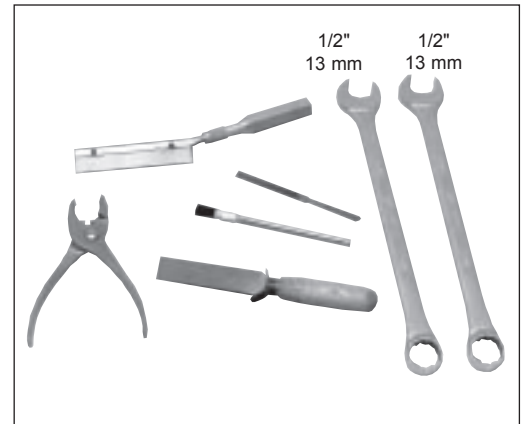

FAX-On-Demand: +1-708-873-3614 • North America: 1-800-861-1700

Tips and Techniques (SP50047) available by FAX-On-Demand.
Los consejos prácticos y técnicas (SP50047) pueden solicitarse por fax.

Conseils et techniques (SP50047) disponibles par fax à la demande.
Tips und Anleitungen (SP50047) auf Faxanfrage erhältlich.

Dicas e Técnicas (SP50047) disponíveis via pedido por fax.
提示與方法 (SP50047) 可以通過電傳獲得

1

Trim cable jacket.
Recortar la envuelta del cable.
Coupez la gaine du câble.
Kabelmantel abziehen.
Retire a capa do cabo.
切整電纜外皮

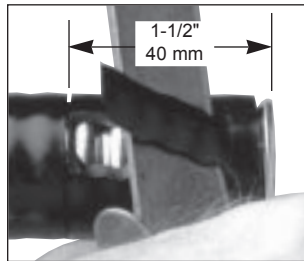

2

Add O-ring, grease, and clamping nut.
Añadir la junta tórica, la grasa y la tuerca sujetadora.
Mettez en place le joint torique, de la graisse et l'écrou de serrage.
O-Ring und Klemmutter vor Montage einfetten.
Coloque o anel O ring, graxa e a porca de aperto.
加 O 型圈，油脂和緊固螺母

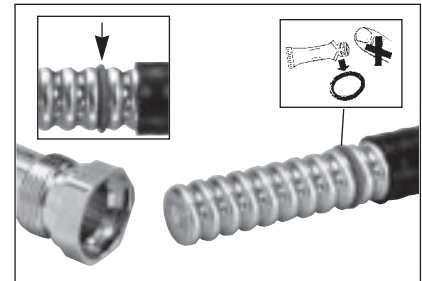

3

Cut outer conductor.
Cortar el conductor externo.
Coupez le conducteur extérieur.
Außenleiter zurückschneiden.
Corte o condutor externo.
切外導體

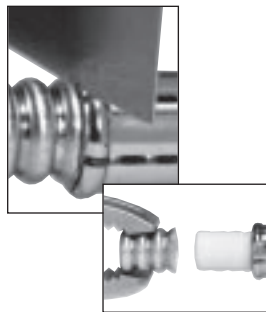

4

Remove foam and adhesive.
Retirar el material de espuma y el adhesivo.
Enlevez la mousse et l'adhésif.
Verschäumung und Klebeband entfernen.
Remove a espuma e o adesivo.
去除泡沫塑料和粘潔劑

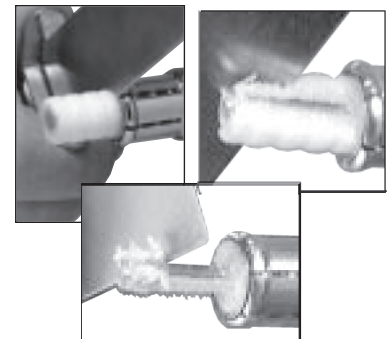

5

Trim inner conductor. Remove debris.
Cortar el conductor interno. Retirar los restos.
Coupez le conducteur intérieur. Enlevez les débris.
Innenleiter abschneiden. Metallspäne entfernen.
Limpe o condutor interno. Remova os detritos.
切整內心導體。去除殘渣

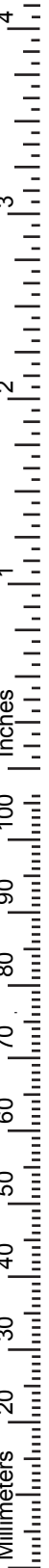
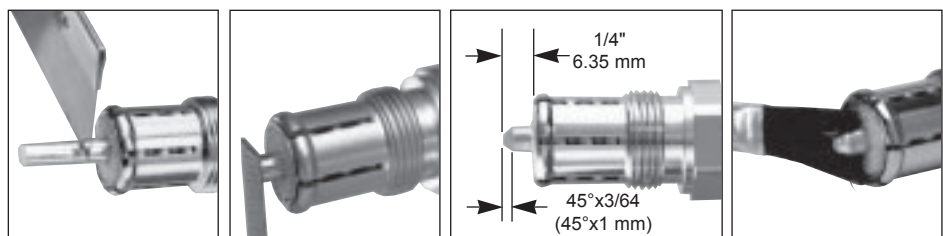

6

Compress foam.
 Comprimir el material de espuma.
 Comprimez la mousse.
 Verschäumung zusammendrücken.
 Comprima a espuma.

壓緊泡沫塑料

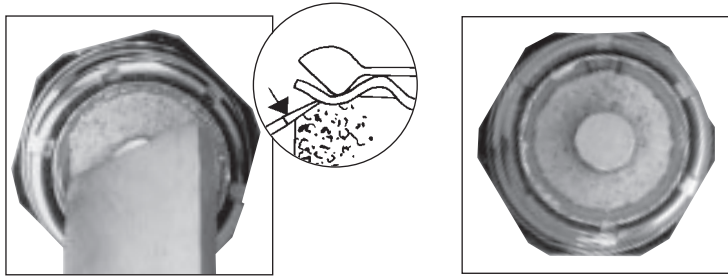

7

Flare outer conductor, examine flare, remove debris
 Acampanar el conductor externo, examinar la forma de campana y retirar los restos.
 Evasez le conducteur extérieur, examinez l'évasement et enlevez les débris.
 Außenleiter aufweiten, Öffnung prüfen und Metallspäne entfernen.
 Flangear o condutor externo, examinar o flangeamento e remover os detritos.

擴張外導體，檢查擴張表面，去除殘骸。

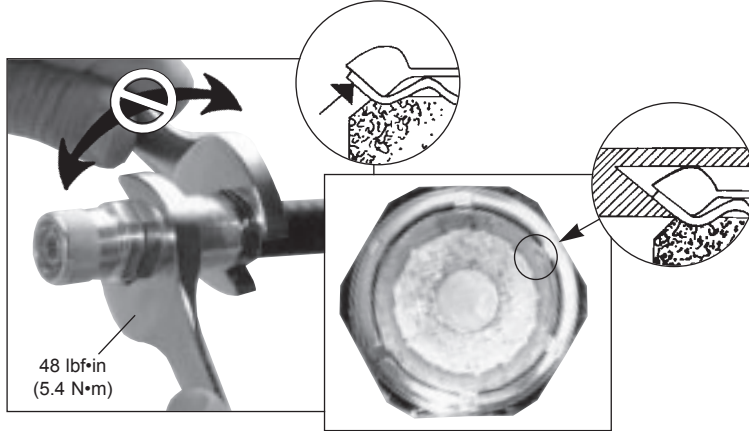

8

Add O-ring and grease. Reassemble connector.
 Añadir la junta tórica y grasa. Montar nuevamente el conector.
 Mettez en place le joint torique et graissez. Réassemblez le connecteur.
 O-Ring vor Montage einfetten. Steckverbindung wieder zusammenbauen.
 Coloque o anel em O ring e graxa. Reinstale o conector.

加 O 型圈和油脂。重新裝配接頭

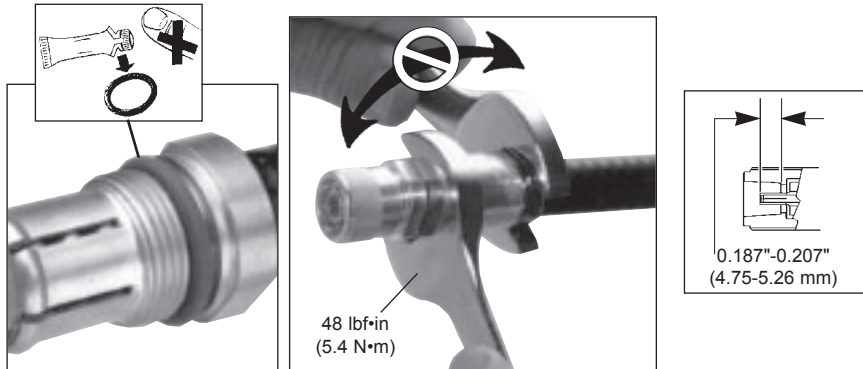

9

Coupling torque.
 Par de acoplamiento.
 Couple de serrage.
 Anschlußdrehmoment.
 Torque de conjugação.
 配合扭矩

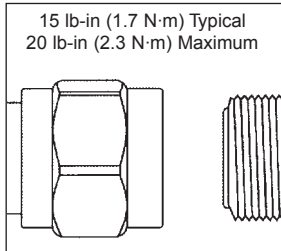

50	表一 有毒有害物质或元素名称及含量标识格式					
	有毒有害物质或元素					
部件名称 (Part Name)	铅 (Pb)	汞 (Hg)	镉 (Cd)	六价铬 (Cr6+)	多溴联苯 (PBB)	多溴二苯醚 (PBDE)
连接器 (Connector)	X	O	O	O	O	O

O: 表示有毒有害物质在该部件所有的均质材料中的含量均在SJ/T 11363-2006规定的限量要求以下。
 X: 表示该有毒有害物质至少在该部件的某一均质材料中的含量超出SJ/T 11363-2006规定的限量要求。

Notice: Andrew disclaims any liability or responsibility for the results of improper or unsafe installation, inspection, maintenance, or removal practices.
Aviso: Andrew no acepta ninguna obligación ni responsabilidad como resultado de prácticas incorrectas o peligrosas de instalación, inspección, mantenimiento o retiro.
Avis: Andrew décline toute responsabilité pour les conséquences de procédures d'installation, d'inspection, d'entretien ou de retrait incorrectes ou dangereuses.
Hinweis: Andrew lehnt jede Haftung oder Verantwortung für Schäden ab, die aufgrund unsachgemäßer Installation, Überprüfung, Wartung oder Demontage auftreten.
Atenção: A Andrew abdica do direito de toda responsabilidade pelos resultados de práticas inadequadas e sem segurança de instalação, inspeção, manutenção ou remoção.
 注意：Andrew 公司申明對於不恰當或不安全的安裝、檢驗、維修或拆卸操作所導致的後果不負任何義務和責任



This product may be covered by one or more of the following patents, or other patents pending. United States 5,154,636; 5,137,470; 5,354,217; 5,344,051; 5,435,745; 5,595,502; Switzerland, Spain, France, United Kingdom 0 495 467; Germany P692 13 034.9; p692 14 199.5; Italy 70,732-BE/96; 71,436-BE/96; Australia 668,812

Andrew Corporation
 3 Westbrook Corporate Center, Suite 900, Westchester, Illinois U.S.A. 60154
 +1 (779) 435-8579 Fax (U.S.A.): 1-800-349-5444
 www.andrew.com

Copyright © 2007 by Andrew Corporation

Customer Service, 24 hours
 U.S.A., Canada, Mexico: 1-800-255-1479
 U.K.: 0800 250055
 Other Europe: +44 592 782 612
 China: +86 512-6256-8805