

# F4A-PDMDR-2M-X

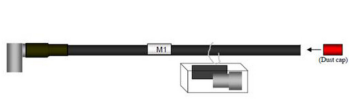

FSJ4-50B SureFlex® Jumper with interface types 7-16 DIN Male and 7-16 DIN Male Right Angle, 2 m

## Product Classification

<b>Product Type</b>	SureFlex® standard
<b>Product Brand</b>	HELIAX®   SureFlex®
<b>Product Series</b>	FSJ4-50B

## General Specifications

<b>Attachment, Connector B</b>	Field attachment
<b>Body Style, Connector A</b>	Straight
<b>Body Style, Connector B</b>	Right angle
<b>Interface, Connector A</b>	7-16 DIN Male
<b>Interface, Connector B</b>	7-16 DIN Male
<b>Specification Sheet Revision Level</b>	A

## Dimensions

<b>Length</b>	2 m   6.562 ft
<b>Nominal Size</b>	1/2 in

## Electrical Specifications

<b>DTF, Connector A</b>	-32 dB
-------------------------	--------

## VSWR/Return Loss

Frequency Band	VSWR, typical	Return Loss, typical (dB)
0–3000 MHz	1.106	25.96
2.2–2.7 GHz	1.083	27.99

## Jumper Assembly Sample Label

# F4A-PDMDR-2M-X



## Environmental Specifications

**Immersion Test Method** Meets IEC 60529:2001, IP68 in mated condition

## Regulatory Compliance/Certifications

Agency	Classification
ISO 9001:2015	Designed, manufactured and/or distributed under this quality management system

## Included Products

- F4PDR-C – 7-16 DIN Male Right Angle for 1/2 in FSJ4-50B cable

# F4PDR-C

---

7-16 DIN Male Right Angle for 1/2 in FSJ4-50B cable



## Product Classification

<b>Product Type</b>	Wireless and radiating connector
<b>Product Brand</b>	HELIAX®

## General Specifications

<b>Body Style</b>	Right angle
<b>Cable Family</b>	FSJ4-50B
<b>Inner Contact Attachment Method</b>	Captivated
<b>Inner Contact Plating</b>	Gold
<b>Interface</b>	7-16 DIN Male
<b>Mounting Angle</b>	Right angle
<b>Outer Contact Attachment Method</b>	Crush-flare
<b>Outer Contact Plating</b>	Trimetal
<b>Pressurizable</b>	No

## Dimensions

<b>Width</b>	31.75 mm   1.25 in
<b>Length</b>	60.96 mm   2.4 in
<b>Right Angle Length</b>	45.72 mm   1.8 in
<b>Diameter</b>	40.39 mm   1.59 in
<b>Nominal Size</b>	1/2 in

## Outline Drawing

# F4PDR-C

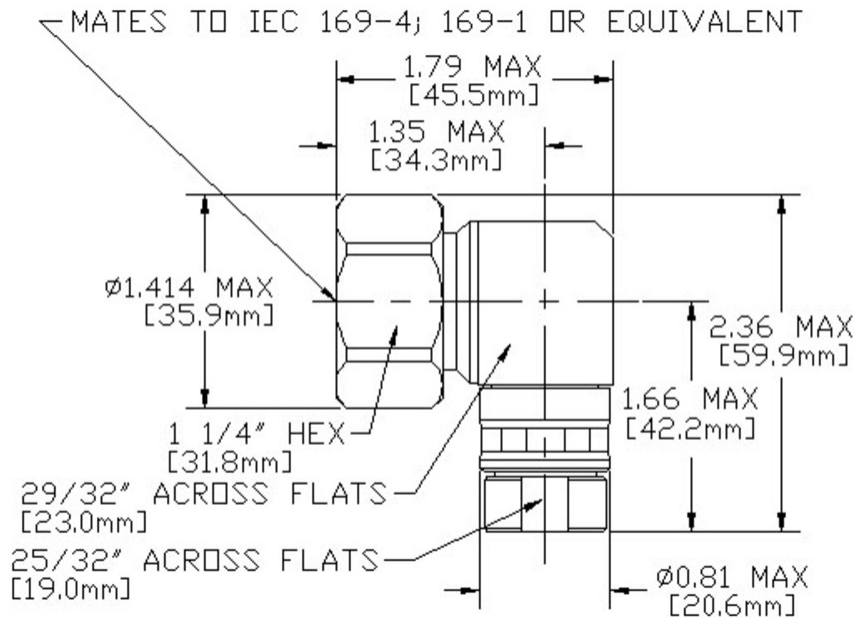

## Electrical Specifications

<b>3rd Order IMD at Frequency</b>	-120 dBm @ 910 MHz
<b>3rd Order IMD Test Method</b>	Two +43 dBm carriers
<b>Insertion Loss Coefficient, typical</b>	0.05
<b>Average Power at Frequency</b>	1.0 kW @ 900 MHz
<b>Cable Impedance</b>	50 ohm
<b>Connector Impedance</b>	50 ohm
<b>dc Test Voltage</b>	2500 V
<b>Inner Contact Resistance, maximum</b>	0.8 mOhm
<b>Insulation Resistance, minimum</b>	5000 MOhm
<b>Operating Frequency Band</b>	0 – 5200 MHz
<b>Outer Contact Resistance, maximum</b>	1.5 mOhm
<b>Peak Power, maximum</b>	15.6 kW
<b>RF Operating Voltage, maximum (vrms)</b>	884 V
<b>Shielding Effectiveness</b>	-110 dB

## VSWR/Return Loss

Frequency Band	VSWR	Return Loss (dB)
50–1000 MHz	1.04	34.16

# F4PDR-C

---

<b>1000–1900 MHz</b>	1.04	34.16
<b>1900–2200 MHz</b>	1.07	29.42
<b>2000–2700 MHz</b>	1.1	26.45
<b>2700–3600 MHz</b>	1.13	24.29
<b>3600–5000 MHz</b>	1.25	19.09

## Mechanical Specifications

<b>Attachment Durability</b>	25 cycles
<b>Connector Retention Tensile Force</b>	889.64 N   200 lbf
<b>Connector Retention Torque</b>	5.42 N-m   47.998 in lb
<b>Coupling Nut Proof Torque</b>	24.86 N-m   220.003 in lb
<b>Coupling Nut Retention Force</b>	1,000.85 N   225 lbf
<b>Coupling Nut Retention Force Method</b>	MIL-C-39012C-3.25, 4.6.22
<b>Insertion Force</b>	200.17 N   45 lbf
<b>Insertion Force Method</b>	IEC 61169-1:15.2.4
<b>Interface Durability</b>	500 cycles
<b>Interface Durability Method</b>	IEC 61169-4:9.5
<b>Mechanical Shock Test Method</b>	MIL-STD-202F, Method 213B, Test Condition C

## Environmental Specifications

<b>Operating Temperature</b>	-55 °C to +85 °C (-67 °F to +185 °F)
<b>Storage Temperature</b>	-55 °C to +85 °C (-67 °F to +185 °F)
<b>Attenuation, Ambient Temperature</b>	20 °C   68 °F
<b>Average Power, Ambient Temperature</b>	40 °C   104 °F
<b>Corrosion Test Method</b>	MIL-STD-1344A, Method 1001.1, Test Condition A
<b>Immersion Depth</b>	1 m
<b>Immersion Test Mating</b>	Mated
<b>Immersion Test Method</b>	IEC 60529:2001, IP68
<b>Moisture Resistance Test Method</b>	MIL-STD-202F, Method 106F
<b>Thermal Shock Test Method</b>	MIL-STD-202, Method 107, Test Condition A-1, Low Temperature -55 °C
<b>Vibration Test Method</b>	IEC 60068-2-6
<b>Water Jetting Test Mating</b>	Mated
<b>Water Jetting Test Method</b>	IEC 60529:2001, IP66

# F4PDR-C

---

## Packaging and Weights

**Weight, net** 207.36 g | 0.457 lb

## \* Footnotes

**Insertion Loss Coefficient, typical**  $0.05\sqrt{\text{freq}}$  (GHz) (not applicable for elliptical waveguide)

**Immersion Depth** Immersion at specified depth for 24 hours