

F2P43A-PDMDM-3M-X



FSJ2P-50 SureFlex® Jumper with interface types 7-16 DIN Male and 7-16 DIN Male, 3 m

OBSOLETE

This product was discontinued on: November 20, 2019

Product Classification

Product Type	Wireless transmission cable assembly
Product Brand	HELIAX® SureFlex®
Product Series	FSJ2-50

General Specifications

Attachment, Connector B	Field attachment
Body Style, Connector A	Straight
Body Style, Connector B	Straight
Interface, Connector A	7-16 DIN Male
Interface, Connector B	7-16 DIN Male
Specification Sheet Revision Level	A

Dimensions

Length	3 m 9.843 ft
Nominal Size	3/8 in

VSWR/Return Loss

Frequency Band	VSWR	Return Loss (dB)
806–960 MHz	1.15	23.13
1427–1535 MHz	1.15	23.13
1700–2300 MHz	1.15	23.13

Jumper Assembly Sample Label

F2P43A-PDMDM-3M-X



Environmental Specifications

Immersion Test Method Meets IEC 60529:2001, IP68 in mated condition

Regulatory Compliance/Certifications

Agency	Classification
ISO 9001:2015	Designed, manufactured and/or distributed under this quality management system



Included Products

- F2TDM-PL – 7-16 DIN Male Positive Lock for 3/8 in FSJ2-50 cable

F2TDM-PL



7-16 DIN Male Positive Lock for 3/8 in FSJ2-50 cable

Product Classification

Product Type	Wireless and radiating connector
Product Brand	HELIAX®
Product Series	FSJ2-50

General Specifications

Body Style	Straight
Cable Family	FSJ2-50
Inner Contact Attachment Method	Captivated
Inner Contact Plating	Silver
Interface	7-16 DIN Male
Mounting Angle	Straight
Outer Contact Attachment Method	Crush-flare
Outer Contact Plating	Trimetal
Pressurizable	No

Dimensions

Height	34.54 mm 1.36 in
Width	34.54 mm 1.36 in
Length	55.12 mm 2.17 in
Diameter	34.54 mm 1.36 in
Nominal Size	3/8 in

Outline Drawing

F2TDM-PL

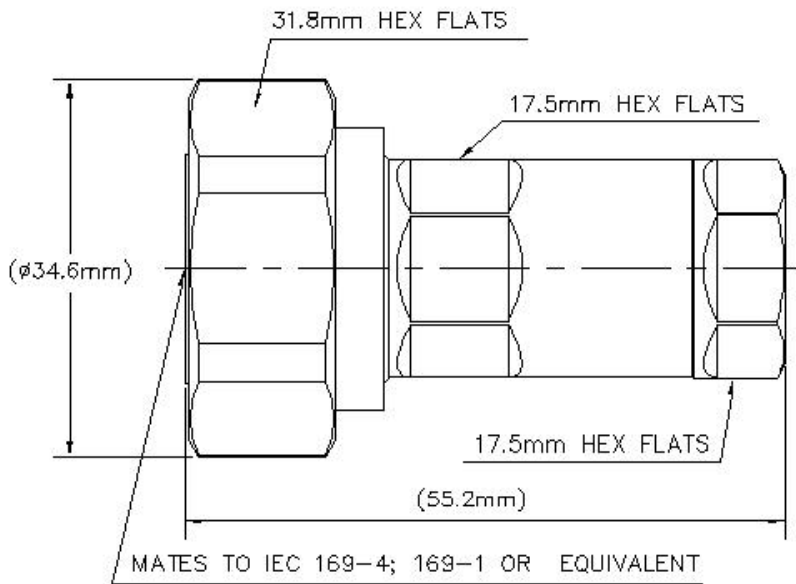

Electrical Specifications

3rd Order IMD at Frequency	-97 dBm @ 910 MHz
3rd Order IMD Test Method	Two +43 dBm carriers
Insertion Loss Coefficient, typical	0.05
Average Power at Frequency	0.7 kW @ 900 MHz
Cable Impedance	50 ohm
Connector Impedance	50 ohm
dc Test Voltage	2300 V
Inner Contact Resistance, maximum	0.4 mOhm
Insulation Resistance, minimum	10000 MOhm
Operating Frequency Band	0 – 8000 MHz
Outer Contact Resistance, maximum	1.5 mOhm
Peak Power, maximum	13.2 kW
RF Operating Voltage, maximum (vrms)	813 V
Shielding Effectiveness	-110 dB

VSWR/Return Loss

Frequency Band	VSWR	Return Loss (dB)
0–960 MHz	1.027	37.51

F2TDM-PL

960–2200 MHz	1.059	30.86
2200–2700 MHz	1.078	28.51
2700–4000 MHz	1.079	28.4
4000–6000 MHz	1.29	18
6000–8000 MHz	1.38	16

Mechanical Specifications

Connector Retention Tensile Force	671.68 N 151 lbf
Connector Retention Torque	2.7 N-m 23.897 in lb
Coupling Nut Proof Torque	35 N-m 309.776 in lb
Coupling Nut Retention Force	1000 N 224.81 lbf
Coupling Nut Retention Force Method	MIL-C-39012C-3.25, 4.6.22
Insertion Force	199.99 N 44.96 lbf
Insertion Force Method	IEC 61169-1:15.2.4
Interface Durability	500 cycles
Interface Durability Method	IEC 61169-4:17
Mechanical Shock Test Method	IEC 60068-2-27

Environmental Specifications

Operating Temperature	-55 °C to +85 °C (-67 °F to +185 °F)
Storage Temperature	-65 °C to +125 °C (-85 °F to +257 °F)
Attenuation, Ambient Temperature	20 °C 68 °F
Average Power, Ambient Temperature	40 °C 104 °F
Average Power, Inner Conductor Temperature	100 °C 212 °F
Corrosion Test Method	IEC 60068-2-11
Immersion Depth	1 m
Immersion Test Mating	Mated
Immersion Test Method	IEC 60529:2001, IP68
Moisture Resistance Test Method	IEC 60068-2-3
Thermal Shock Test Method	IEC 60068-2-14
Vibration Test Method	IEC 60068-2-6

Packaging and Weights

F2TDM-PL

Weight, net

133.03 g | 0.293 lb

Regulatory Compliance/Certifications

Agency

Classification

CHINA-ROHS

Below maximum concentration value

ISO 9001:2015

Designed, manufactured and/or distributed under this quality management system

REACH-SVHC

Compliant as per SVHC revision on www.commscope.com/ProductCompliance

ROHS

Compliant

UK-ROHS

Compliant



* Footnotes

Insertion Loss Coefficient, typical 0.05√freq (GHz) (not applicable for elliptical waveguide)

Immersion Depth Immersion at specified depth for 24 hours