

F4A-PDRDM-4M-X

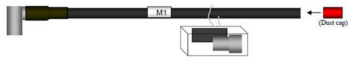

FSJ4-50B SureFlex® Jumper with interface types 7-16 DIN Male Right Angle and 7-16 DIN Male, 4 m

Product Classification

Product Type	SureFlex® standard
Product Brand	HELIAX® SureFlex®
Product Series	FSJ4-50B

General Specifications

Attachment, Connector B	Field attachment
Body Style, Connector A	Right angle
Body Style, Connector B	Straight
Interface, Connector A	7-16 DIN Male
Interface, Connector B	7-16 DIN Male
Specification Sheet Revision Level	A

Dimensions

Length	4 m 13.123 ft
Nominal Size	1/2 in

Electrical Specifications

DTF, Connector A	-32 dB
-------------------------	--------

VSWR/Return Loss

Frequency Band	VSWR, typical	Return Loss, typical (dB)
0–3000 MHz	1.106	25.96
2.2–2.7 GHz	1.083	27.99

Jumper Assembly Sample Label

F4A-PDRDM-4M-X



Environmental Specifications

Immersion Test Method Meets IEC 60529:2001, IP68 in mated condition

Regulatory Compliance/Certifications

Agency	Classification
ISO 9001:2015	Designed, manufactured and/or distributed under this quality management system

Included Products

- F4HM-D - 4.3-10 Male for 1/2 in FSJ4-50B cable
- F4HMP-D - 4.3-10 Male Push Pull for 1/2 in FSJ4-50B cable
- F4PDMV2-C - 7-16 DIN Male for 1/2 in FSJ4-50B cable

F4HM-D



4.3-10 Male for 1/2 in FSJ4-50B cable

Product Classification

Product Type	Wireless and radiating connector
Product Brand	HELIAX®
Product Series	FSJ4-50B FSJ4RK-50B
Ordering Note	CommScope® standard product (Global)

General Specifications

Body Style	Straight
Cable Family	FSJ4-50B
Inner Contact Attachment Method	Captivated
Inner Contact Plating	Silver
Interface	4.3-10 Male
Mounting Angle	Straight
Outer Contact Attachment Method	Crush-flare
Outer Contact Plating	Trimetal

Dimensions

Length	62.48 mm 2.46 in
Diameter	24.89 mm 0.98 in
Nominal Size	1/2 in

F4HM-D

Outline Drawing

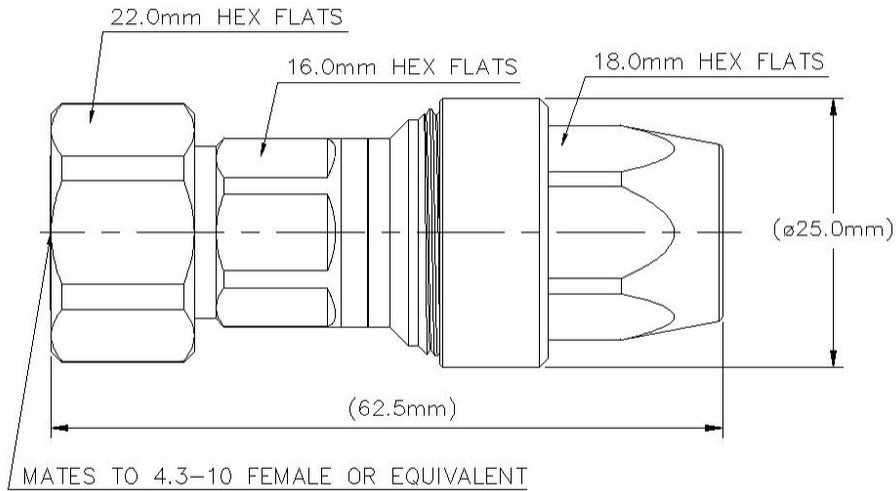

Electrical Specifications

3rd Order IMD at Frequency	-116 dBm @ 910 MHz
3rd Order IMD Dynamic Test Method	Two +43 dBm carriers
3rd Order IMD Dynamic, typical	-116 dB
Insertion Loss Coefficient, typical	0.05
Average Power at Frequency	600.0 W @ 900 MHz
Cable Impedance	50 ohm
Connector Impedance	50 ohm
dc Test Voltage	2500 V
Inner Contact Resistance, maximum	0.8 mOhm
Insulation Resistance, minimum	5000 MOhm
Operating Frequency Band	0 – 7500 MHz
Outer Contact Resistance, maximum	1.5 mOhm
Peak Power, maximum	22.5 kW
RF Operating Voltage, maximum (vrms)	884 V

F4HM-D

Shielding Effectiveness -110 dB

VSWR/Return Loss

Frequency Band	VSWR	Return Loss (dB)
45–1000 MHz	1.02	40.09
1000–2700 MHz	1.03	36.61
2700–3800 MHz	1.065	30.04
3800–6000 MHz	1.15	23.13

Mechanical Specifications

Attachment Durability	25 cycles
Connector Retention Tensile Force	889.64 N 200 lbf
Connector Retention Torque	5.42 N-m 47.998 in lb
Coupling Nut Proof Torque	10 N-m 88.507 in lb
Coupling Nut Retention Force	449.27 N 101 lbf
Interface Durability	100 cycles
Interface Durability Method	IEC 61169-4:9.5
Mechanical Shock Test Method	IEC 60068-2-27

Environmental Specifications

Operating Temperature	-55 °C to +85 °C (-67 °F to +185 °F)
Storage Temperature	-55 °C to +85 °C (-67 °F to +185 °F)
Attenuation, Ambient Temperature	20 °C 68 °F
Average Power, Ambient Temperature	40 °C 104 °F
Corrosion Test Method	IEC 60068-2-11
Immersion Depth	1 m
Immersion Test Mating	Mated
Immersion Test Method	IEC 60529:2001, IP68
Moisture Resistance Test Method	IEC 60068-2-3
Thermal Shock Test Method	IEC 60068-2-14
Vibration Test Method	IEC 60068-2-6
Water Jetting Test Mating	Mated
Water Jetting Test Method	IEC 60529:2001, IP66

F4HM-D

Packaging and Weights

Weight, net 100 g | 0.22 lb

Regulatory Compliance/Certifications

Agency	Classification
CHINA-ROHS	Below maximum concentration value
ISO 9001:2015	Designed, manufactured and/or distributed under this quality management system
REACH-SVHC	Compliant as per SVHC revision on www.commscope.com/ProductCompliance
ROHS	Compliant
UK-ROHS	Compliant



* Footnotes

Insertion Loss Coefficient, typical $0.05\sqrt{\text{freq (GHz)}}$ (not applicable for elliptical waveguide)

Immersion Depth Immersion at specified depth for 24 hours

F4HMP-D



4.3-10 Male Push Pull for 1/2 in FSJ4-50B cable

Product Classification

Product Type	Wireless and radiating connector
Product Brand	HELIAX®
Product Series	FSJ4-50B FSJ4RK-50B
Ordering Note	CommScope® standard product (Global)

General Specifications

Body Style	Straight
Cable Family	FSJ4-50B
Inner Contact Attachment Method	Captivated
Inner Contact Plating	Silver
Interface	4.3-10 Male
Mounting Angle	Straight
Outer Contact Attachment Method	Crush-flare
Outer Contact Plating	Trimetal

Dimensions

Length	62.48 mm 2.46 in
Diameter	27.94 mm 1.1 in
Nominal Size	1/2 in

F4HMP-D

Outline Drawing

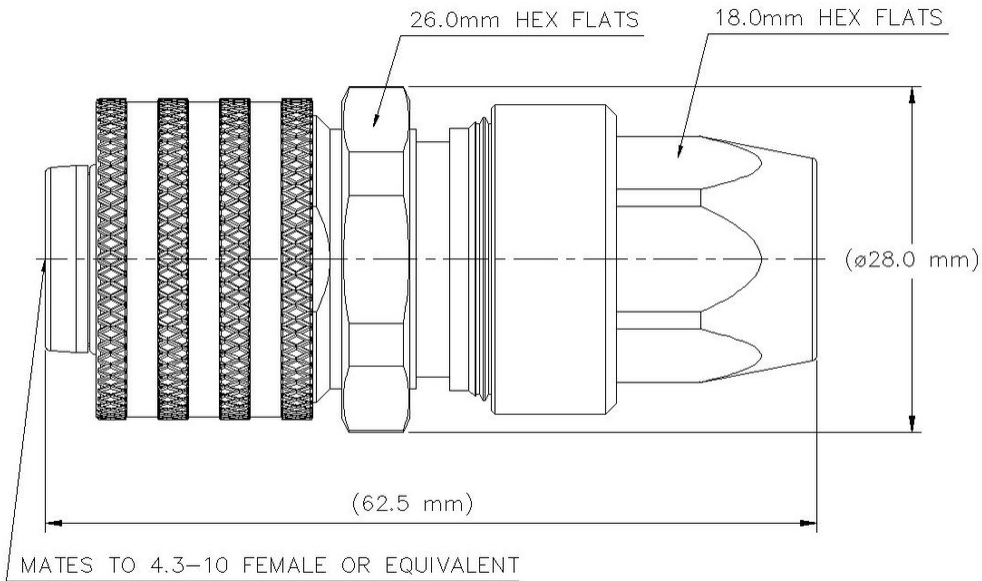

Electrical Specifications

3rd Order IMD at Frequency	-116 dBm @ 910 MHz
3rd Order IMD Dynamic Test Method	Two +43 dBm carriers
3rd Order IMD Dynamic, typical	-116 dB
Insertion Loss Coefficient, typical	0.05
Average Power at Frequency	600.0 W @ 900 MHz
Cable Impedance	50 ohm
Connector Impedance	50 ohm
dc Test Voltage	2500 V
Inner Contact Resistance, maximum	0.8 mOhm
Insulation Resistance, minimum	5000 MOhm
Operating Frequency Band	0 – 7500 MHz
Outer Contact Resistance, maximum	1.5 mOhm
Peak Power, maximum	22.5 kW
RF Operating Voltage, maximum (vrms)	884 V
Shielding Effectiveness	-110 dB

F4HMP-D

VSWR/Return Loss

Frequency Band	VSWR	Return Loss (dB)
45–1000 MHz	1.02	40.09
1000–2700 MHz	1.03	36.61
2700–3800 MHz	1.065	30.04
3800–6000 MHz	1.15	23.13

Mechanical Specifications

Attachment Durability	5 cycles
Connector Retention Tensile Force	889.64 N 200 lbf
Connector Retention Torque	5.42 N-m 47.998 in lb
Interface Durability	25 cycles
Interface Durability Method	IEC 61169-4:9.5
Mechanical Shock Test Method	IEC 60068-2-27

Environmental Specifications

Operating Temperature	-55 °C to +85 °C (-67 °F to +185 °F)
Storage Temperature	-55 °C to +85 °C (-67 °F to +185 °F)
Attenuation, Ambient Temperature	20 °C 68 °F
Average Power, Ambient Temperature	40 °C 104 °F
Corrosion Test Method	IEC 60068-2-11
Immersion Depth	1 m
Immersion Test Mating	Mated
Immersion Test Method	IEC 60529:2001, IP68
Moisture Resistance Test Method	IEC 60068-2-3
Thermal Shock Test Method	IEC 60068-2-14
Vibration Test Method	IEC 60068-2-6
Water Jetting Test Mating	Mated
Water Jetting Test Method	IEC 60529:2001, IP66

Packaging and Weights

F4HMP-D

Weight, net

123.37 g | 0.272 lb

Regulatory Compliance/Certifications

Agency

Classification

ISO 9001:2015

Designed, manufactured and/or distributed under this quality management system

* Footnotes

Insertion Loss Coefficient, typical 0.05√freq (GHz) (not applicable for elliptical waveguide)

Immersion Depth Immersion at specified depth for 24 hours

F4PDMV2-C



7-16 DIN Male for 1/2 in FSJ4-50B cable

Product Classification

Product Type	Wireless and radiating connector
Product Brand	HELIAX®
Product Series	FSJ4-50B FSJ4RK-50B
Ordering Note	CommScope® standard product (Global)

General Specifications

Body Style	Straight
Cable Family	FSJ4-50B
Inner Contact Attachment Method	Captivated
Inner Contact Plating	Silver
Interface	7-16 DIN Male
Mounting Angle	Straight
Outer Contact Attachment Method	Crush-flare
Outer Contact Plating	Trimetal
Pressurizable	No

Dimensions

Length	50.04 mm 1.97 in
Diameter	34.54 mm 1.36 in
Nominal Size	1/2 in

Electrical Specifications

3rd Order IMD at Frequency	-120 dBm @ 910 MHz
3rd Order IMD Test Method	Two +43 dBm carriers

F4PDMV2-C

Insertion Loss Coefficient, typical	0.05
Average Power at Frequency	1.0 kW @ 900 MHz
Cable Impedance	50 ohm
Connector Impedance	50 ohm
dc Test Voltage	2500 V
Inner Contact Resistance, maximum	0.8 mOhm
Insulation Resistance, minimum	5000 MOhm
Operating Frequency Band	0 – 7500 MHz
Outer Contact Resistance, maximum	1.5 mOhm
Peak Power, maximum	15.6 kW
RF Operating Voltage, maximum (vrms)	884 V
Shielding Effectiveness	-110 dB

VSWR/Return Loss

Frequency Band	VSWR	Return Loss (dB)
0–2200 MHz	1.032	36.06
2200–2700 MHz	1.046	32.96
2700–3000 MHz	1.052	31.92

Mechanical Specifications

Attachment Durability	25 cycles
Connector Retention Tensile Force	889.64 N 200 lbf
Connector Retention Torque	5.42 N-m 47.998 in lb
Coupling Nut Proof Torque	24.86 N-m 220.003 in lb
Coupling Nut Retention Force	1,000.85 N 225 lbf
Coupling Nut Retention Force Method	MIL-C-39012C-3.25, 4.6.22
Insertion Force	200.17 N 45 lbf
Insertion Force Method	IEC 61169-1:15.2.4
Interface Durability	500 cycles
Interface Durability Method	IEC 61169-4:9.5
Mechanical Shock Test Method	MIL-STD-202F, Method 213B, Test Condition C

Environmental Specifications

F4PDMV2-C

Operating Temperature	-55 °C to +85 °C (-67 °F to +185 °F)
Storage Temperature	-55 °C to +85 °C (-67 °F to +185 °F)
Attenuation, Ambient Temperature	20 °C 68 °F
Average Power, Ambient Temperature	40 °C 104 °F
Corrosion Test Method	MIL-STD-1344A, Method 1001.1, Test Condition A
Immersion Depth	1 m
Immersion Test Mating	Mated
Immersion Test Method	IEC 60529:2001, IP68
Moisture Resistance Test Method	MIL-STD-202F, Method 106F
Thermal Shock Test Method	MIL-STD-202, Method 107, Test Condition A-1, Low Temperature -55 °C
Vibration Test Method	MIL-STD-202F, Method 204D, Test Condition B
Water Jetting Test Mating	Mated
Water Jetting Test Method	IEC 60529:2001, IP66

Packaging and Weights

Weight, net	136.08 g 0.3 lb
--------------------	-------------------

Regulatory Compliance/Certifications

Agency	Classification
CHINA-ROHS	Below maximum concentration value
ISO 9001:2015	Designed, manufactured and/or distributed under this quality management system
REACH-SVHC	Compliant as per SVHC revision on www.commscope.com/ProductCompliance
ROHS	Compliant
UK-ROHS	Compliant



* Footnotes

Insertion Loss Coefficient, typical	0.05√freq (GHz) (not applicable for elliptical waveguide)
Immersion Depth	Immersion at specified depth for 24 hours