

MST-12RH00-A0150U



MST, Fiber Optic Multiport Service Terminal, 12-port, square 4x3 port, dielectric flat loose tube cable, 150 ft

- Hardened connectors are factory-terminated and environmentally sealed for use in optical drop cable deployments
- Plug and play adapter ports ensure rapid cable installment in the outside plant access section of the network
- Multiport Service Terminals incorporate hardened connector technology that is designed to withstand the rugged outside plant environment

Alternative products available:

HST-BCHNA0150NN000 HST, NOVUX™ Hardened Standard Terminal, 12-port, Dielectric flat loose tube cable, 150 ft/45 m

Product Classification

Regional Availability	Asia Latin America North America
Product Type	Access terminal, without splitter/tap
Product Series	MST

General Specifications

Cable Type	Dielectric - Flat - Loose Tube
Cable, quantity	1
Distribution Type	12 ports
Enclosure Color	Black
Mounting	Handhole Pedestal Pole Strand
Port Type	Hardened full-size SC/APC
Port, quantity	12
Splitter, quantity	0
Stub Type	Stub tail

Dimensions

Height	286 mm 11.26 in
Width	188 mm 7.402 in
Depth	92.1 mm 3.626 in

MST-12RH00-A0150U

Cable Length, stub	150 ft (45 m)
Cable Outer Diameter	4.5 x 8.1 mm (0.18 x 0.32 in)

Dimension Drawing

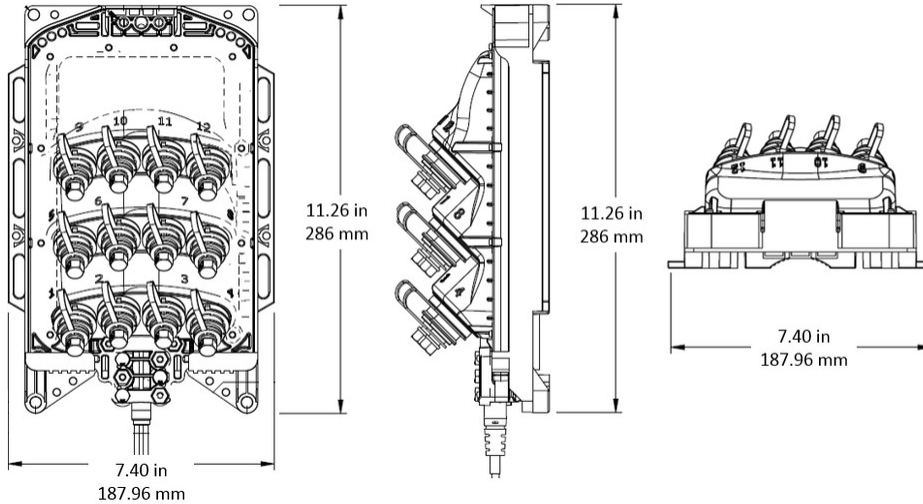

Ordering Tree

MST - R H 0 0 -

Terminal model

04	4 ports
06	6 ports
08	8 ports
12	12 ports
0N	1 x 4 splitter
0J	1 x 8 splitter

Cable type

A	Dielectric, flat, loose tube
B	Locatable, flat, loose tube

*0-300 ft lengths of cable is automatically coiled (option U), for greater than 300 ft cable lengths, choose U or A option.

Mounting style*

U	Universal: Terminal is on top of the spool; stub deploys first
A	Reversal spool: Terminal is on the bottom of the spool; terminal deploys first

Standard cable stub length

0050	50 feet
0100	100 feet
0200	200 feet
0500	500 feet
0750	750 feet
1000	1000 feet
1500	1500 feet
2000	2000 feet

Standard lengths shown; metric lengths available

Material Specifications

Enclosure Material Type	Gasketed hardened plastic
--------------------------------	---------------------------

Optical Specifications

MST-12RH00-A0150U

Fiber Type	G.657.A1/A2
Operating Wavelength Range	1260 – 1635 nm
Attenuation Cable Coefficient, maximum	0.30 dB/km @ 1550 nm 0.40 dB/km @ 1310 nm
Attenuation Terminal Connectors, maximum	0.4 dB
Directivity, minimum	60 dB
Insertion Loss, Terminal Connector, typical	0.16 dB
Return Loss, Connector, minimum	65 dB

Environmental Specifications

Operating Temperature	-40 °C to +70 °C (-40 °F to +158 °F)
Relative Humidity	5%–100%, condensing
Environmental Space	Above ground Below ground Buried
Flammability Rating	UL 94 5VA
Qualification Standards	IEC 60529, IP68 + 2 m waterhead Telcordia GR-3120-CORE Telcordia GR-326-CORE Telcordia GR-771-CORE
UV Resistance	UV stabilized

Packaging and Weights

Included	Enclosure (1) Universal mounting bracket (1)
Packaging quantity	1
Packaging Type	Box Carton
Weight, without cable	1.36 kg 2.998 lb

Regulatory Compliance/Certifications

Agency	Classification
CHINA-ROHS	Below maximum concentration value
ISO 9001:2015	Designed, manufactured and/or distributed under this quality management system
REACH-SVHC	Compliant as per SVHC revision on www.commscope.com/ProductCompliance
ROHS	Compliant
UK-ROHS	Compliant



Included Products

MST-12RH00-A0150U

MST-UMB-4312 – Universal MST Mounting Bracket

MST-UMB-4312



Universal MST Mounting Bracket

Product Classification

Regional Availability	EMEA Latin America North America
Product Type	Mounting bracket
Product Series	MST NDX

General Specifications

Color	Black
--------------	-------

Environmental Specifications

Environmental Space	Outdoor
----------------------------	---------

Packaging and Weights

Packaging quantity	1
Packaging Type	Bag Carton

Regulatory Compliance/Certifications

Agency	Classification
CHINA-ROHS	Below maximum concentration value
REACH-SVHC	Compliant as per SVHC revision on www.commscope.com/ProductCompliance
ROHS	Compliant
UK-ROHS	Compliant

