

HR300B - HEAT REGENERATIVE DEHYDRATOR

USER MANUAL

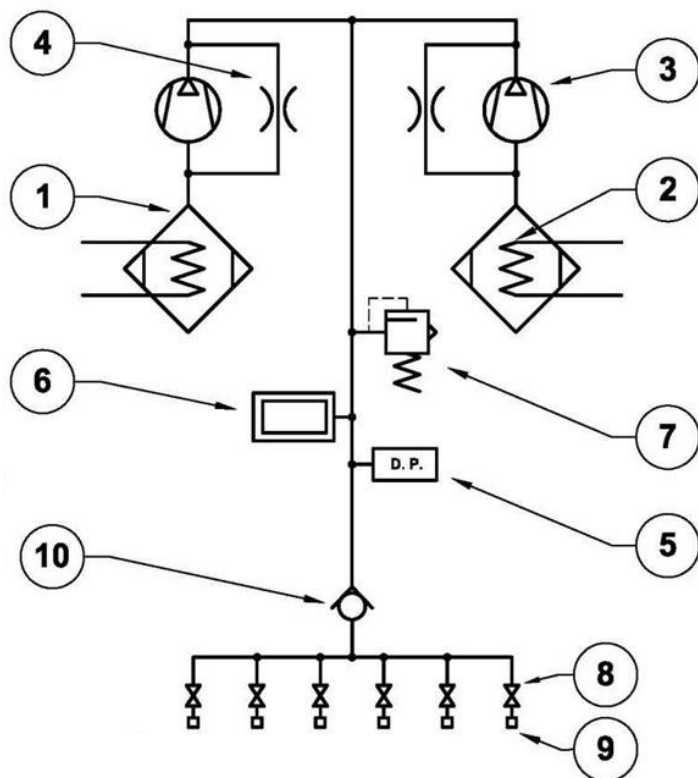

- 1 DRYING CHAMBER
- 2 HEATER
- 3 PUMP
- 4 AIR BACKWASHING HOLE
- 5 HUMIDITY PROBE
- 6 DIGITAL PRESSURE GAUGE
- 7 RELIEF VALVE
- 8 SHUT OFF VALVE
- 9 DRY AIR OUTLET
- 10 ONE-WAY VALVE

1 SAFETY PRECAUTIONS









This is the safety alert symbol. It is used to alert you to personal injury hazards. Obey all safety instructions that follow this symbol to reduce the risk of possible injury or death as well as property damage.







WARNING

READ CAREFULLY THE PRODUCT INSTALLATION, OPERATING AND MAINTENANCE MANUAL. THIS PRODUCT MUST BE INSTALLED ONLY BY QUALIFIED TECHNICIANS. FOLLOW ALL APPLICABLE LOCAL AND STATE CODES AND REGULATIONS.





GENERAL SAFETY INFORMATIONS

	<ul style="list-style-type: none"> Do not apply any modification or adjustment to the machine.
	<ul style="list-style-type: none"> The machine must be installed only following the instructions provided by the user manual.
	<ul style="list-style-type: none"> IMPORTANT: improper installation and operation of the machine will result in unsatisfactory performance or failure of the system and will also void your warranty.
	<ul style="list-style-type: none"> Make sure that the installation place has a good ambient ventilation.
	<ul style="list-style-type: none"> Air must not be discharged in the same fuel exhaust discharge outlet of other gas machines.
	<ul style="list-style-type: none"> Ventilation grid must not be choked.
	<ul style="list-style-type: none"> If the power supply cable is damaged it must be replaced only by the manufacturer or authorized and qualified personnel to avoid dangerous situations.





SAFETY INSTRUCTIONS

	<ul style="list-style-type: none"> Follow the instructions provided together with the machine.
	<ul style="list-style-type: none"> DANGER: make attention during machine displacement or movement. Electrocution, burst and burn hazard. Use always qualified gloves.
	<ul style="list-style-type: none"> Do not install or use the machine if it is damaged.
	<ul style="list-style-type: none"> Check the correct in-plane position after the installation with a bubble level.

ELECTRICAL INSTALLATION

	<ul style="list-style-type: none"> • WARNING: burn and electrocution hazard.
	<ul style="list-style-type: none"> • The machine must be electrically grounded. Check for the correct ground connection.
	<ul style="list-style-type: none"> • Do not use extension cables.
	<ul style="list-style-type: none"> • DANGER: do not touch any power supply cable or power supply connector with wet hands.
	<ul style="list-style-type: none"> • This machine respects the CEE directive.

OPERATION SAFETY PRECAUTIONS

	<ul style="list-style-type: none"> • DANGER: risk of death, burn, injuries or property damage.
	<ul style="list-style-type: none"> • Do not apply any modification or adjustment to the machine technical specifications.
	<ul style="list-style-type: none"> • WARNING: do not place or keep any inflammable liquid, material or object near, over or inside the machine.
	<ul style="list-style-type: none"> • Before any work or maintenance is performed on the machine, turn off the power supply and release pressure in the system.

2 FEATURES

- Output pressure : factory set at 3 psi,
programmable from 1,5 psi to 7 psi
- Maximum flow rate : ≥ 300 l/h
- Relief valve : factory set at 10 psi \pm 15 %
- Output air dew point : better than -40°C at 20°C ambient temperature and
80% ambient Relative Humidity
- Desiccant regeneration : automatic by heating
- Local alarms : low/high pressure, high humidity
- Local failures : heater1, heater2, pump1, pump2, humidity probe
- Remote alarms and failures : the summary alarm (failure) is remotely signaled by a
SPDT relay
- Low pressure alarm : factory set at 1,5 psi,
programmable from 0,5 psi
- High pressure alarm : factory set at 8,5 psi,
programmable up to 10 psi
- High humidity alarm : set at 10% of Relative Humidity \pm 2%
- Standard measures : air pressure, hour meter
- Bicolor LED : power on, alarms and failures
- Acoustic noise : < 50 dBA at 1 m far and 1,5 m height
- Enclosure degree of protection : IP20 according to IEC529
- Operating temperature : -10 °C ÷ +50 °C
- Storage temperature : -30 °C ÷ +60 °C
- Power supply : AC 110-240 V, 50/60 Hz (from 90 to 264 V), or
DC 48/60 V (from 36 to 72 V)
- Max power consumption : AC 100 VA, DC 60 W (during regeneration phase)
- Average power consumption : AC 60 VA, DC 35 W
- Dimensions (mm) : 19" rack mounting - height 3U, depth 260 mm
ETSI N3 rack mounting - height 6U, depth 260 mm
wall mounting - width 487, height 132, depth 360 mm
- Weight : 9 kg
- Standard outlets : 6 outlets, each with ON/OFF valve
- Outlets fitting : suitable for 3/8" PE hose
- European Community Directives : 2014/35/EU Low Voltage Directive
2014/30/EU Electromagnetic Compatibility Directive
- Safety Standard : EN 62368-1
- Electromagnetic Compatibility Standard : EN 55032; EN 55035

3 DESCRIPTION

The HR300B is a heat regenerative dehydrator unit designed for continuous operation and automatic duty. This dehydrator supplies dry air up to 300 l/h with dew point better than -40 °C.

Output pressure can be chosen within the range from 1,5 psi to 7 psi.

Air is dried by means of two drying chambers containing molecular sieve. While one chamber dries (molecules of water are captured by adsorption) the other one is regenerated by heating and backwashed with a reverse dry air flow.

Air is compressed by two pumps; a continuous tracking of output pressure is performed. The PWM (Pulse Width Modulation) technique is used to control speed of two pumps (one for each drying chamber) so to optimize pump duty, power consumption, acoustic noise, and improve reliability. Pumps speed control avoids mechanical pressure regulators that introduce undesirable pressure losses and a worst response to air flow needs.

Dry air is vented out by six independent air outlets with hose-tail fittings accessible from the rear side of the equipment. Each outlet has an independent shutoff valve.



The equipment is designed for wall, shelf, 19" and ETSI N3 standard racks mountings.

Wide-range power supply is provided: 110-240 VAC 50/60 Hz and 48/60 VDC.

The dehydrator does not need pre-settings nor warm up time before startup. It does not need preventive maintenance along its lifetime. See § 5.1 for details on startup.

No radioactive or chemically hazardous components are used.

The following devices are available on the front panel:

- digital display: output air pressure, hour meter, alarm and failure messages, target pressure and low/high alarm pressure thresholds settings
- two function keys ( and ) to scroll and modify settings
- power on, alarms and failures via a bicolor LED
- shut off air outlet valves

On the right side of the frontal panel, also accessible from the rear side (see § 4.2), are available no. 6 air outlets (hose-tail fittings according to the equipment version).

On the rear panel are accessible:

- DC and AC power supply connectors
- remote alarm connector

3.1 Ancillary kit

The ancillary kit includes:

- mating electrical connectors for AC and DC power supply and for alarm connector
- rack fixing screws
- ETSI N3 racks fixing kit
- wall fixing kit

4 INSTALLATION

4.1 Mounting

The dehydrator is designed for low vibration and low noise and can safely be placed in a 19” or N3 standard rack or cabinet. It is also suitable for wall and shelf mounting.

The dehydrator is factory assembled for the 19” rack mounting.

It is strongly suggested to place the dehydrator in the upper part of the rack without any other equipment above.



If the dehydrator cannot be placed in the upper part of the rack, it is mandatory to leave an upper free space of at least one 19” rack unit from the dehydrator to the closest equipment.

4.1.1 ETSI N3 rack mounting

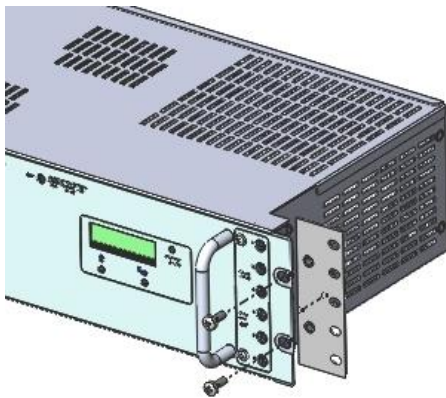

Fig. 1 - ETSI N3 rack mounting

- ETSI-N3 movable brackets and the relevant screws are supplied in the ancillary kit.
- Tighten the ETSI-N3 brackets with the same screws used for rack 19” rack mounting.
- Put the dehydrator into the frame and lock it with the screws supplied in the ancillary kit.

4.1.2 Wall mounting

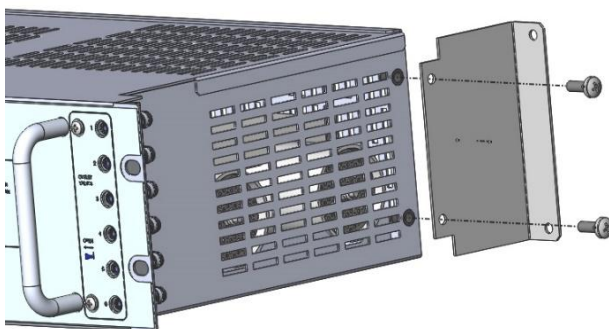

Fig. 2 - Wall mounting

- The relevant wall brackets and screws are supplied in the ancillary kit.
- Tighten the two brackets to the equipment with the four screws
- Plug the alarm and power supply connectors before mounting the dehydrator on the wall.

The following picture shows screw hole patterns (measures are in mm):

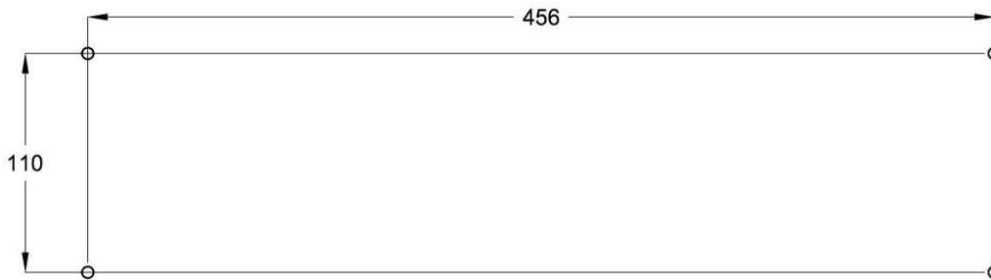

Fig. 3 - Screw hole patterns

4.2 Pneumatic connections

The dehydrator has six air outlets available on right side of frontal panel and on the rear side also. Each outlet is equipped with an independent shutoff valve.

Screw the relevant knob into the shutoff valve that need to be opened.

Open, by pulling the knob, only valves corresponding to used outlets; keep all the others closed by pushing the knob.

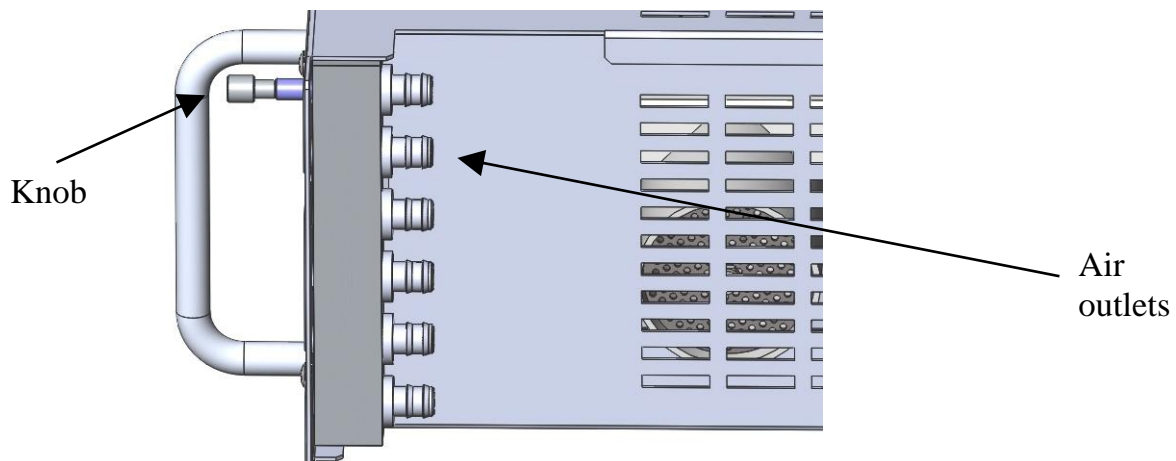

Fig. 4 - Air outlets

After use, to prevent accidental operations, screw the knob into the default position in the center front side of the dehydrator.

4.3 Electrical connections

Three male connectors are available, on the rear side, for the electrical connections:

- 1) a standard IEC320/C14 plug connector, for AC power supply (110-240V)
- 2) J1, 3 pin D-sub-3W3-C, for DC power connection (48/60V)
- 3) J2, 9 pin D-sub type, for remote alarm output.

AC or DC input power supply can be chosen according to the power supply availability in the installation site.

Beside the IEC320/C14 plug connector, under the cover, are located no. 2 replaceable fuses (3.15A fast-acting).

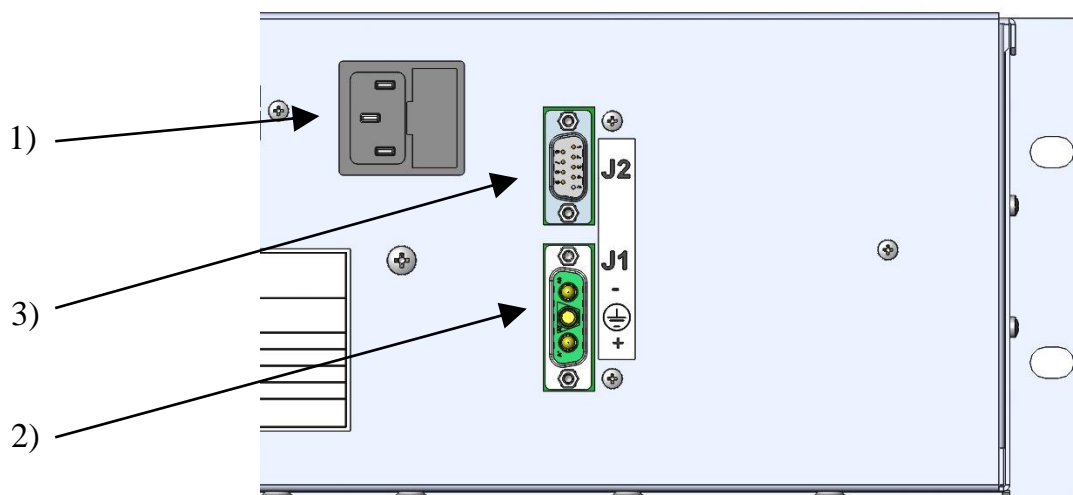

Fig. 5 - Electrical connections

4.3.1 AC Power connection (110-240V)

An appropriate disconnect device shall be provided as part of the building installation.

Disconnect the dehydrator from supply for servicing.



Protection for short-circuit and earth failures of power conductors are a function assigned to installation area system.

The dehydrator requires a protective and functional earthing.

The earthing terminal is available in the power supply connector, marked with the symbol  in the image below.

Check for correct type and rated voltage range: power rating is indicated on the dehydrator rear side.

Use the standard IEC320/C14 plug connector if AC power supply is required. A relevant mating connector is supplied in the ancillary kit.

The picture on the right shows the earth cable position.

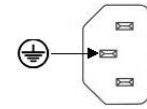

Fig. 6 - Earth position

4.3.2 DC Power connection 48/60 V

Alternatively, to AC input power supply, the dehydrator can be supplied with DC low voltage supply.



An appropriate disconnect device shall be provided as part of the building installation.

Disconnect the dehydrator from power supply for servicing.

Protection for short-circuit and earth failures of power conductors are a function assigned to installation area system.

Protective earthing is mandatory only for power supply above 60 VDC.

The earthing terminal is available in the power supply connector (J1) and it is marked with the symbol .

Do not connect the dehydrator to power supply before having checked for correct type and rated voltage. See power rating marking on the dehydrator rear side.

The dehydrator can operate with either:

- negative polarity connected to ground (e. g. 0/+48 V systems)
- positive polarity connected to ground (e. g. -48/0 V systems).

A relevant mating connector and a protective shell are supplied in the ancillary kit.

Connect power cable wires to the mating connector according to the following pinout.

Pin number	J1 label	Function	0/+48 V systems	-48/0 V systems
A1	+	Positive power supply input	+ 48 V	0 V
A2		Protective earthing		
A3	-	Negative supply input	0 V	- 48V

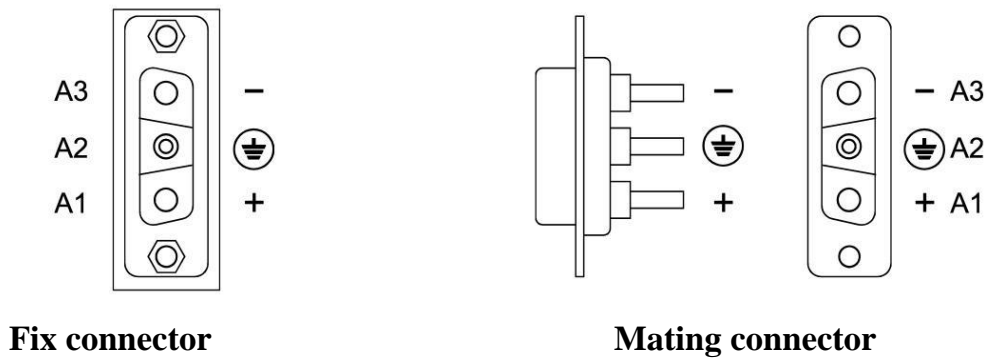

Fig. 7 - Fix and mating connectors

4.3.3 Remote alarms and failures relay

A summary (OR) alarms and failures output is provided by an internal SPDT (Single Pole Double Throw) relay.

The maximum switching current is 0,5 A.

The maximum switching voltage is 60 V.

Remote alarm connector J2, 9 pin D-Sub type, is located on the rear panel.

A mating connector and a protective shell are supplied in the ancillary kit.

The following table shows the connector pinout:

J2 - Alarms and failures connector pinout	
Pin number	Function
1	Common
5	Closed on alarm
9	Open on alarm







In case of power failure, the relay switches to alarm position.

5 OPERATION



If the equipment has been left not working or stored for a long period, both the drying chambers will be wet. The dehydrator must be left switched on, continuously, for not less than 48 hours to let both the drying chambers to regenerate. During regeneration all air outlets must be closed. The *High Humidity Alarm* must be ignored during drying chambers regeneration.

5.1 First startup or startup after dehydrator maintenance

 WARNING	<p>THIS PRODUCT MUST BE INSTALLED ONLY BY QUALIFIED TECHNICIANS. FOLLOW ALL APPLICABLE LOCAL AND STATE CODES AND REGULATIONS.</p>
	<p>IMPORTANT: improper installation and operation of the machine will result in unsatisfactory performance or failure of the system and will also void your warranty.</p>
	<p>Make sure that the installation place has a good ambient ventilation.</p>
	<p>Air must not be discharged in the same fuel exhaust discharge outlet of other gas machines.</p>
	<p>Ventilation grid must not be choked.</p>

Open all the valves relevant to the used air outlets before proceeding with first startup.

Once the dehydrator is powered on, after a few seconds, dry air starts flowing out of the outlets.

Depending on the volume of the user system to be pressurized, it may take some time for the output pressure to achieve the target pressure. The low pressure alarm is disabled in the first 30 seconds at each startup; then low pressure alarm is hold until target pressure is reached.

At the very first startup, it is mandatory to purge the transmission line with dry air (by keeping open the opposite side of the pressurized line) for a period of time to be calculated by the following formula:

$$\text{purging time (hours)} = (3 \times V) / 300$$

Where V is the pressurized plant volume in liters.

	<p>IMPORTANT: improper transmission line purging will lead to alarms in the dehydrator. These alarms can show fix or intermittent and they are the signals of the improper system purging. Unsatisfactory performance or failure of the system or alarms due to improper transmission line purging will void product warranty.</p>
---	---



IMPORTANT: while purging, open only the dehydrator outlets connected to the system to be pressurized.

After purging is finished, close the opposite side in the pressurized plant. Alarms must be ignored during the purging phase.



IMPORTANT: after finishing the installation, it is mandatory to fill the **INSTALLATION REPORT (ANNEX I)** and to provide a soft copy to **ANDREW** to prove that the installation has been done properly.

5.2 Normal operation

The dehydrator is designed for continuous operation and automatic duty and does not require any preventive maintenance.

A built-in test is carried out at every start-up to check the correct operation of the drying chambers, the pumps and the humidity sensor. Failures messages are promptly pointed out in the second row of the display (see §5.4).

When the dehydrator works normally, the **bicolor LED is solid green** and **no alarm or failure messages are pointed out** in the second row of the display (see §6).

5.3 Bicolor LED

The front bicolor LED (see fig. 8) is solid green during normal operation and switches to red when an alarm or failure (or more) occurs.

5.4 Alarms description

The following **alarm messages** are available in the display:

LOW PRESSURE	Low pressure alarm occurs when the system pressure is lower than the low pressure alarm threshold (see §6.2). Low pressure alarm is disabled in the first 30 seconds after power on.
HIGH PRESSURE	High pressure alarm occurs when the system pressure is higher than the high pressure alarm threshold (see §6.2).
HIGH HUMIDITY	High humidity alarm occurs when the output air flow humidity is higher than 10%. High humidity alarm can show up at first start-up if the dehydrator has been stocked in a humid place for a long time (see §5). While, if high humidity alarm occurs during normal operation, there is a failure in the dehydrator.

When a **failure message** is addressed in the display, it means that a failure has been detected and a **corrective maintenance is required** (see §7).

Hereafter are listed all **failure messages**:

H1 NOT WORKING	The heater1 in drying chamber n. 1 is fault.
H2 NOT WORKING	The heater2 in drying chamber n. 2 is fault.
P1 NOT WORKING	The pump1 is fault.
P2 NOT WORKING	The pump2 is fault.
HS NOT WORKING	The Humidity Probe is fault.

6 MENU FUNCTIONS

On front side of the dehydrator there is a display with two function keys.

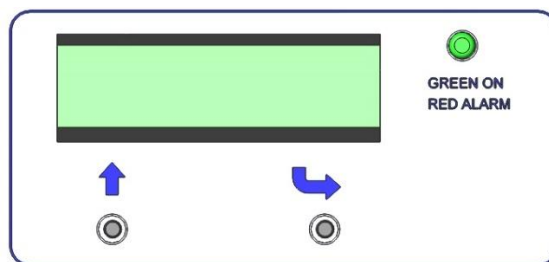



Fig. 8 – Display and bicolor led

The pressure can be displayed in **kPa** or **psi**.

To switch from kPa to psi and vice-versa, press the key  while powering the dehydrator ON.

6.1 Data menu

Some menus are arranged in “pages” and user can scroll the menus by pressing the key .

On startup the following *main page*¹ is displayed; the operating pressure and the hour meter values are displayed:

P	r	e	s	s	u	r	e		2	0		k	P	a	
h	o	u	r	m	e	t	e	r		0	0	0	3	1	2

The first row displays the operating pressure: in the example pressure is “20 kPa”.

The second row shows the hour meter value. In the example the dehydrator has been running for 312 hours.



Hereafter an example of pressure displayed in psi:

P	r	e	s	s	u	r	e		3	.	0		p	s	i
h	o	u	r	m	e	t	e	r		0	0	0	3	1	2

When alarm(s) or failure(s) are active, the hour meter value is automatically replaced by the alarm or the failure message (see §5.4):

P	r	e	s	s	u	r	e		4		k	P	a
	L	O	W		P	R	E	S	S	U	R	E	

This example shows the operating pressure is “4 kPa” (0,6 psi). It is also assumed the low pressure alarm threshold is the low pressure factory default threshold (i.e. 10 kPa or 1,5 psi).

¹ By pressing  key, a new page is displayed. The display provides *auto return function* to *main page*: the timeout is one minute. By pressing the key  the user can scroll all the available service pages (*secondary pages*) until *main page* is selected again.

The message string “LOW PRESSURE” is the relevant alarm message of the *low pressure* condition (see §5.4). When an alarm occurs, the LED lights red. When more than one alarm or failure are active, the relevant message strings to pending alarms or failures alternate one each other on the second row of the display.

6.2 Target pressure and alarm threshold settings

By pressing the key **↩** (from *main page*, see §6.1), the **target pressure setting page** is displayed:

P	r	e	s	s	u	r	e		s	e	t			
	p	o	i	n	t	:			3	.	0	p	s	i

The example shows that the pressure target is set at 3 psi.

Press the key **↑** to increase the pressure target: only increment feature is provided. When the maximum selectable value is reached (i.e. 7 psi), the minimum allowable value (i.e. 1.5 psi) is automatically displayed at the next key pressing. The value increases continuously by keeping the key pressed down. Press the key **↩** to scroll to the next page to **enter** the new target pressure setting². Press twice the key **↩** to reach **low pressure setting page** directly from the main page:

L	o	w		p	r	e	s	s	u	r	e			
	a	l	a	r	m	:			1	.	5	p	s	i

The example shows that the low pressure alarm threshold is set at 1.5 psi.

Press the key **↑** to increase the low pressure threshold: only increment feature is provided. When the maximum value is achieved, target pressure value (selected in the previous menu) **minus 1 psi** (depending the current measurement unit of pressure, see §6), the minimum allowable value (0.5 psi) is automatically displayed at the next key pressing. The value will increase automatically keeping the key pressed down.

Press the key **↩** to **enter** the new low pressure alarm threshold and to scroll to next page (high pressure setting menu). Press three times the key **↩** to reach the **high pressure setting page** directly from the main page:

H	i	g	h		p	r	e	s	s	u	r	e		
	a	l	a	r	m	:			7	.	0	p	s	i

The example says that the high pressure alarm threshold is set at 7 psi.

Press the key **↑** to increase the displayed value: only increment feature is provided. When the maximum value of 7 psi is achieved, the target pressure value **plus 1 psi** (depending the current measurement unit of pressure, see §6) is automatically displayed at the next key pressing. The value increases continuously by keeping the key pressed down.

Press the key **↩** to **enter** the new high pressure alarm threshold and to return to the main page.

² In order to avoid unwanted changes in the operating pressure, target pressure is not modified until exiting the setting page.



7 CORRECTIVE MAINTENANCE AND SPARE PARTS

The dehydrator does not require any preventive maintenance.

In case of dehydrator failure contact **ANDREW Customer Service**.

In case of servicing made by the customer itself, **ANDREW** will supply the necessary spare parts and support.

In case of servicing, it is mandatory to keep in mind:

	<u>Disconnect the dehydrator from power supply</u> before servicing.
	Due to high temperature of some parts (purposely marked) inside the dehydrator, it is mandatory to <u>wait for at least one hour</u> after switch the dehydrator off, before servicing inside.

Spare part list:

Description	Code
Drying chambers kit	K14516.001
Electronic boards kit	K17199.002
Diaphragm pumps Kit	K15906.004
Fuse kit	K17517

(Note: on orders always mention the dehydrator S/N that is printed on the rear label).

8 OUTLINE

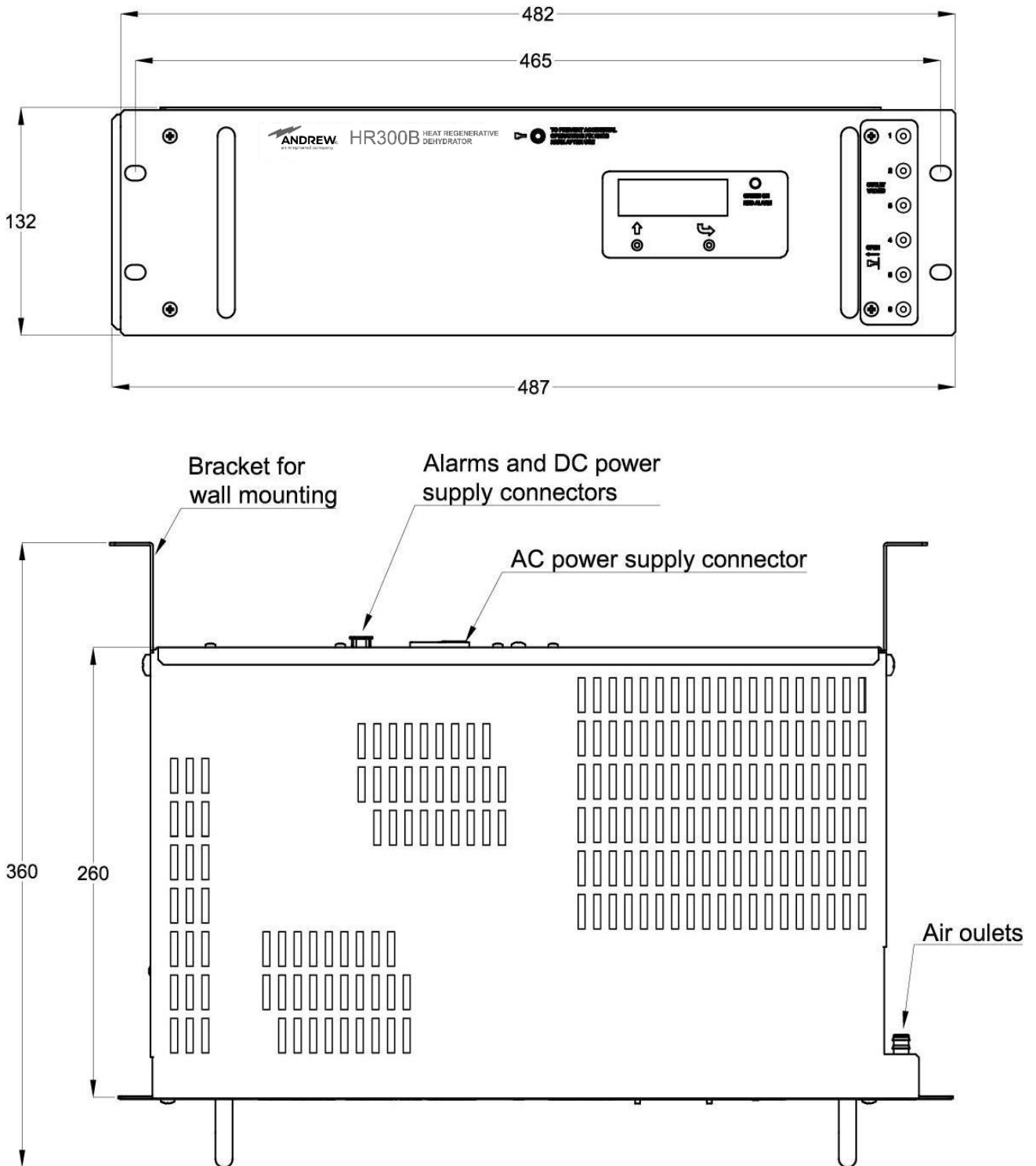

Dimensions in mm

ANNEX I

INSTALLATION REPORT

WORK ORDER No.		CUSTOMER	
P/N	HR300B	S/N	
INSTALLATION SITE		ADDRESS	
CITY		STATE	
POSTAL CODE		TEL.	

ID	Item	Comment
1	Type of transmission line	
2	No. of transmission lines	
3	Total transmission line length [feet]	
4	Total transmission line volume [litres]	
5	Total no. of junctions	
6	Size of the purging opening of the pressurized line	
7	No. of dehydrator outlets connected to the system	
8	No. of dehydrator outlets opened during purging	
9	Purging starting: date and time	
10	Purging finishing: date and time	
11	After purging the opening has been closed?	
12	After purging the dehydrators shows any alarm?	
13	After purging the front LED is solid green?	
14	After purging the hour meter shows?	
15	Dehydrator is installed indoor?	
16	Installation place has a good ambient ventilation?	
17	Installation place has air conditioning?	
18	Dehydrator ventilation grids are choked?	
19	How much room is left over the dehydrator [inches]	
20	Are pressurized lines exposed to external ambient?	

Date/...../.....

Operator:.....