

Safety Grated Waveguide Bridge Channel, 12 in x 10 ft

Product Classification

Product Type Waveguide bridge channel

Dimensions

Height 76.2 mm | 3.0 in

Length 3.0 m | 10.0 ft

Weight 31.8 kg | 70.0 lb

General Specifications

Application Waveguide bridge kit, 12 in

Includes Bridge channel

Material Type Hot dip galvanized steel

Package Quantity 1

Outline Drawing

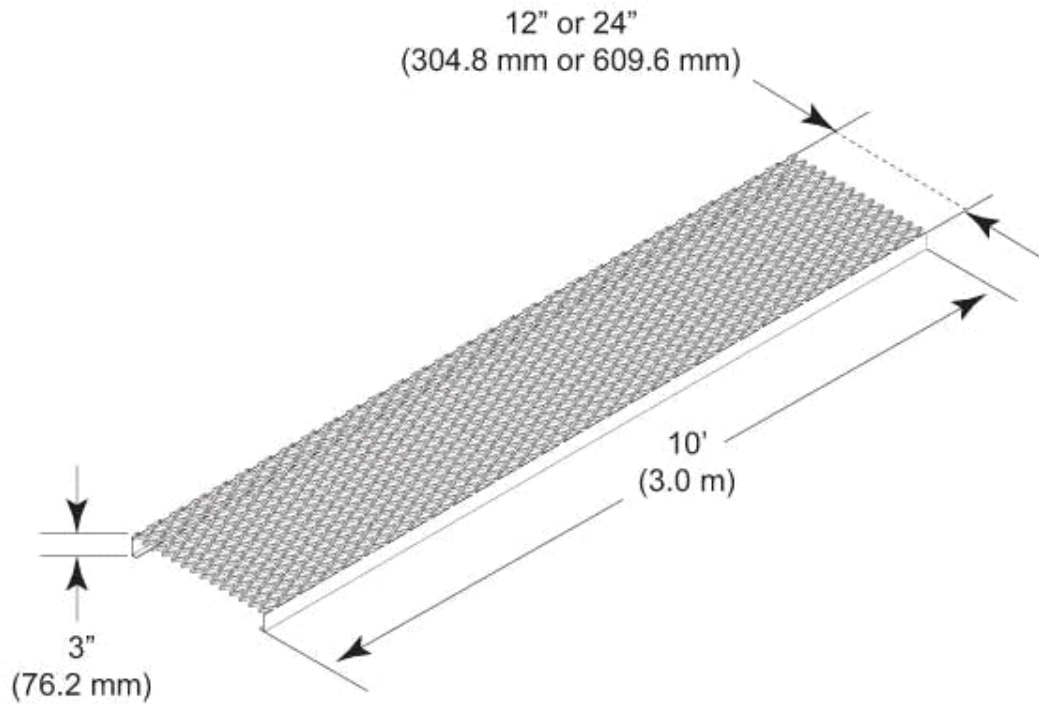

Regulatory Compliance/Certifications

Agency

ISO 9001:2015

Classification

Designed, manufactured and/or distributed under this quality management system

